

22092

PaperSAFE®

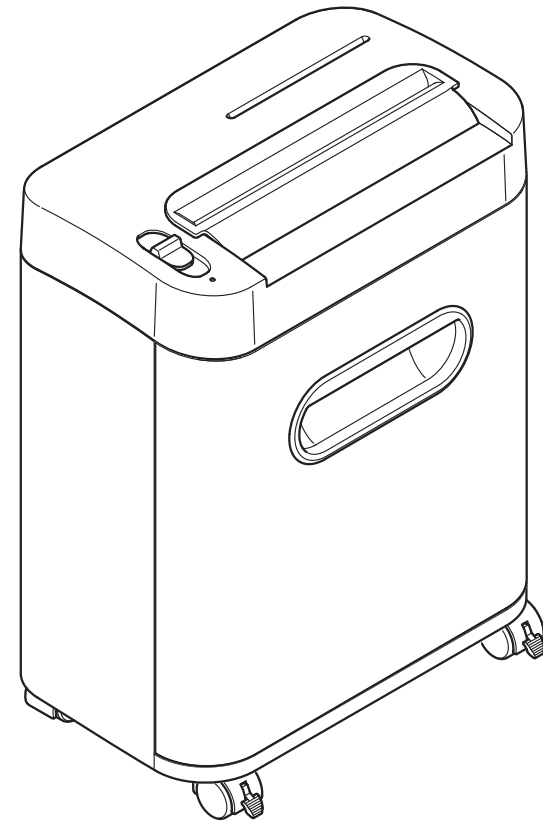

Headquarters:

Novus Dahle GmbH & Co. KG
Breslauer Straße 34-38
49808 Lingen | Germany

Service contact:

Novus Dahle GmbH & Co. KG
Nikolaus-A.-Otto-Straße 11
96472 Rödental | Germany
Tel.: +49 9563 75299-0
Fax: +49 9563 75299-333
E-Mail: info@dahle.de
Web: www.dahle.de

DE	Originalbetriebsanleitung	4
UK/US	Translation from the original operating instructions	6
FR	Traduction à partir du mode d'emploi original	8
ES	Traducción del manual de instrucciones original.	10
IT	Traduzione dal manuale d'uso originale.	12
PT	Tradução do manual de utilização original	14
NL	Vertaling van de originele handleiding	16
DK	Oversættelse af den originale betjeningsvejledning	18
FI	Käännös alkuperäisestä käyttöohjeesta	20
NO	Oversettelse av den opprinnelige bruksanvisningen	22
SE	Översättning ur originalbruksanvisningen	24
SI	Prevod originalnega navodila za uporabo	26
HR	Prijevod originalnih uputa za uporabu	28
HU	Az eredeti kezelési utasítás fordítása	30
RU	Перевод из оригинального руководства по эксплуатации.	32
EE	Algupärase kasutusjuhendi tõlge	34
LT	Originalios naudojimo instrukcijos vertimas.	36
LV	Tulkojums no sākotnējās lietošanas pamācības	38
CZ	Překlad originálního návodu k obsluze	40
SK	Preklad z pôvodného návodu na obsluhu	42
PL	Tłumaczenie oryginalnej instrukcji obsługi	44
RO	Traducere din instrucțiunile de utilizare originale	46
BG	Превод от оригиналното ръководство за употреба	48
TR	Orijinal kullanım kılavuzundan çeviri	50
GR	Μετάφραση του πρωτότυπου εγχειριδίου χρήσης	52
AE	ترجمة من دليل الاستعمال الأصلي	54
JP	取扱説明書原本からの翻訳	56
CN	原始操作说明书的翻译	58

DE Originalbedienungsanleitung



ACHTUNG!

Lesen Sie VOR Inbetriebnahme des Aktenvernichters die Bedienungsanleitung und Sicherheitshinweise aufmerksam durch. Die Hinweise müssen angewendet werden! Bewahren Sie die Bedienungsanleitung für den späteren Gebrauch auf.

Inhaltsverzeichnis

1.	Wichtige Informationen	4
1.4.	Lieferumfang	60
1.5.	Technische Daten	60
2.	Bedienung	61
2.5.	Papiervernichtung	62
2.8.	Überladen (overload)	63
2.10.	Überhitzt (overheat)	64
2.11.	CD/DVD-, Kartenvernichtung	65
3.	Wartung	66
3.1	Schnittgut entleeren	66
3.3	Mögliche Störungen	66
3.4	Gerät reinigen	66

1.1. Bestimmungsgemäße Verwendung, Gewährleistung

Dieser Aktenvernichter ist zum Vernichten von Papier bestimmt.

Verschleiß, Schäden durch unsachgemäßen Gebrauch sowie Eingriffe von dritter Stelle fallen weder unter die Gewährleistung noch unter die Garantie.

Dieser Aktenvernichter ist nicht für den industriellen Einsatz geeignet







1.2. Sicherheitshinweise



- Das Gerät nicht in der Nähe einer Wärmequelle aufstellen!
- Das Gerät nur stehend lagern, transportieren und betreiben!
- Am Gerät nur Flüssigkeiten und Gase verwenden, welche den DAHLE-Richtlinien entsprechen!
- Das Gerät darf nicht geöffnet werden!

- Das Gerät nur in geschlossenen Räumen, bei 10°C bis 25°C und einer nichtkondensierenden Luftfeuchtigkeit von 15% bis 95% betreiben!
- Die Kurzschlussicherheit der Gebäudeinstallation ist sicherzustellen (max. 20A).
- Das Gerät nicht im Leerlauf betreiben!
- Einzugschächte nur einzeln benutzen!

 **Entsorgen Sie den Aktenvernichter fach- und umweltgerecht bei einer autorisierten Sammelstelle. Geben Sie keine Teile des Aktenvernichters oder der Verpackung in den Hausmüll.**

1.3. Piktogrammlegende

-  Wichtige Information
-  Benutzerinformation/Sicherheitshinweise lesen.
-  **ACHTUNG**
Das Gerät standsicher auf dem Boden und mit 100 mm Abstand zur Wand aufstellen, Stauwärme vermeiden, Feststellbremsen betätigen (Typenabhängig).
-  Nicht in der Nähe von ätzenden Stoffen verwenden.
-  Nicht in der Nähe von brennbaren Flüssigkeiten oder Gasen verwenden.
-  Automatischer Anlauf

-  Nicht der Nässe aussetzen
-  Dieser Aktenvernichter ist nicht zur Benutzung durch Kinder bestimmt (das Produkt ist kein Spielzeug).
-  Berühren Sie die Papierzuführung nicht mit den Händen.
-  Berühren Sie die Papierzuführung nicht mit Kleidungsstücken!
-  Berühren Sie die Papierzuführung nicht mit den Haaren!
-  Halten Sie Spraydosen fern!
-  Büro- und Heftklammern vor dem Vernichtungsvorgang entfernen!
-  Keine Disketten einführen!
-  Vor Wartungsarbeiten den Aktenvernichter von der Stromversorgung trennen!
-  Technische Daten - Technische Änderungen vorbehalten!
-  Betriebslautstärke im Leerlauf
-  Papier-Partikelschnitt
-  CD/DVD-Streifenschnitt
-  Karten-Streifenschnitt
-  Gewicht
-  Netzstecker dient als Trennvorrichtung der Stromversorgung.
-  Die Netzsteckdose muss jederzeit leicht zugänglich sein!
-  Bedienung
-  Aktenvernichter in Bereitschaft
-  Aktenvernichter in Betrieb
-  **STOP** Automatische Abschaltung!
-  Bei längerem Betrieb und/oder Überlastung schaltet der Aktenvernichter automatisch zum Abkühlen ab.
-   **Wartungshinweise / Störungsbeseitigung**
-  Behälter voll
-   **Mögliche Störungen**
-  automatische Abschaltung bei offenem Gehäuse

UK/US Translation from the original operating instructions



IMPORTANT!
Read the operating and safety instructions BEFORE placing the document shredder into operation.
You must follow the instructions.
Keep the operating instructions in a safe place ready for later use.

Table of Contents

1.	Important information	6
1.4.	Scope of supply	60
1.5.	Technical specifications	60
2.	Operation	61
2.5.	Paper shredding	62
2.8.	Overload	63
2.10.	Overheated	64
2.11.	CD, DVD & card shredding	65
3.	Maintenance	66
3.1	Emptying shredding waste	66
3.3	Possible malfunctions	66
3.4	Cleaning the shredder	66

1.1. Intended use, warranty

The document shredder is designed for shredding paper.
Wear, damage due to improper use or unauthorised modifications and repairs are not covered by the warranty or the guarantee.
This document shredder is not suitable for industrial use.

1.2. Safety instructions

- Do not place the device near a source of heat.
- Store, transport and operate the device in an upright position only.
- Only use liquids and gases on the device that comply with DAHLE guidelines.
- Do not open up the device.
- Only operate the device in closed spaces, at tem-

peratures between 10°C and 25°C and at a non-condensing humidity between 15% and 95%.

- Ensure that the building installation has short-circuit protection (max. 20 A).
- Do not operate the document shredder without inserting documents.
- Use paper trays one at a time only.



Dispose of the document shredder properly in an environmentally friendly way at an authorised collection point. Do not dispose of any parts of the document shredder or packaging in domestic waste.

1.3. Key to pictograms



Important information



User information/safety instructions



WARNING



Place the device in a stable position on the floor, leaving a gap of 100 mm to the wall, ensure no heat can accumulate, engage brake mechanisms (depending on type)



Do not use near caustic substances.



Do not use near inflammable liquids or gases.



Automatic start-up



Do not expose to moisture



This document shredder is not intended to be used by children (the product is not a toy).



Do not touch the paper feed with your hands.



Do not allow items of clothing to come into contact with the paper feed.



Do not allow your hair to come into contact with the paper feed.



Keep spray cans away from the device.



Remove paper clips and staples before shredding.



Do not insert any diskettes.



Disconnect the document shredder from the electrical power supply before performing maintenance work.



Technical specifications - Subject to technical modifications.



Noise level when operated without shredding documents



Shredded paper particles



Shredded CD/DVD strips



Shredded card strips



Weight



The power plug is used to disconnect the power supply.



The mains socket must be easily accessible at all times.



How to use



Document shredder on standby



Document shredder in operation



Automatic shut-down!



The document shredder will switch off automatically to cool down if used for a long time and /or if overloaded



Maintenance instructions / troubleshooting



Container full



Possible malfunctions



Automatic switch-off when housing is open

FR Traduction à partir du mode d'emploi original

ATTENTION !
Lisez attentivement le mode d'emploi et les consignes de sécurité AVANT de mettre en marche le destructeur de documents !
Les consignes doivent être appliquées !
Conservez le mode d'emploi pour une utilisation ultérieure.

Sommaire

1. Informations importantes 8
1.4. Contenu 60
1.5. Caractéristiques techniques 60
2. Utilisation 61
2.5. Destruction de documents 62
2.8. Surcharge (overload) 63
2.10. Surchauffe (overheat) 64
2.11. Destruction de CD/DVD et de cartes 65
3. Entretien 66
3.1. Vider le matériau découpé 66
3.3. Problèmes possibles 66
3.4. Nettoyer l'appareil 66

1.1. Utilisation conforme, garantie

Ce destructeur de documents est destiné à détruire des documents papier.
L'usure, les dégradations dues à une utilisation incorrecte et les interventions de tierces personnes ne sont pas couvertes par la responsabilité du fabricant ni par la garantie.
Ce destructeur de documents ne convient pas pour une utilisation industrielle.



1.2. Consignes de sécurité

- Ne pas installer l'appareil à proximité d'une source de chaleur !
- Ranger, transporter ou utiliser l'appareil en position verticale uniquement !
- Utiliser à proximité de l'appareil uniquement des liquides et des gaz conformes aux directives DAHLE !
- Il est interdit d'ouvrir l'appareil !

























- Utiliser l'appareil dans des locaux fermés uniquement, à des températures comprises entre 10 °C et 25 °C et une hygrométrie non condensée comprise entre 15 % et 95 % !
- L'installation électrique du bâtiment doit être protégée contre les courts-circuits (max. 20 A).
- Ne pas laisser l'appareil tourner à vide !
- Utiliser les ouvertures d'insertion seulement séparément !

 **Éliminez le destructeur de documents dans le respect des règles et de l'environnement dans un point de collecte autorisé. Ne jetez pas de composants du destructeur de documents ou de l'emballage dans les ordures ménagères.**

1.3. Légende des pictogrammes

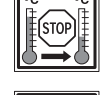
-  Information importante
 Lire les informations pour l'utilisateur/consignes de sécurité

-  **ATTENTION**
Placer l'appareil au sol de manière à ce qu'il soit bien stable et à une distance de 100 mm du mur, éviter la chaleur stagnante, actionner les freins de blocage (selon le modèle)
-  Ne pas utiliser l'appareil à proximité de substances corrosives.
-  Ne pas utiliser l'appareil à proximité de liquides ou de gaz inflammables.
-  Démarrage automatique

-  Ne pas exposer l'appareil à l'humidité.
-  Ce destructeur de documents n'est pas destiné à être utilisé par des enfants (le produit n'est pas un jouet).
-  Ne touchez pas le dispositif d'alimentation du papier avec les mains.
-  Ne touchez pas le dispositif d'alimentation du papier avec vos vêtements !
-  Ne touchez pas le dispositif d'alimentation du papier avec vos cheveux !
-  Tenez les bombes aérosols à l'écart !
-  Retirer les trombones et les agrafes des documents avant de les détruire !
-  Ne pas introduire de disquettes !
-  Débrancher le destructeur de documents de l'alimentation électrique avant de procéder aux opérations d'entretien !
-  Caractéristiques techniques - Sous réserve de modifications techniques !
-  Volume sonore à vide
-  Coupe en particules de papier
-  Coupe en bandes de CD/DVD
-  Coupe en bandes de cartes
-  Poids
-  La prise sert de dispositif de sectionnement de l'alimentation électrique.
-  La prise de courant doit toujours être aisément accessible !
-  Utilisation
-  Destructeur de documents en veille
-  Destructeur de documents en marche
-  Arrêt automatique !
-  Le destructeur de documents s'éteint automatiquement après une utilisation prolongée et/ou en cas de surcharge afin de refroidir.
-  Consignes d'entretien/Dépannage
-  Bac plein
-  Problèmes possibles
-  Arrêt automatique en cas de boîtier ouvert

ES Traducción del manual de instrucciones original

ATENCIÓN:
 Lea detenidamente las instrucciones de uso y las indicaciones sobre seguridad antes de poner en marcha la destructora. Deben cumplirse todas las indicaciones. Guarde el manual de instrucciones por si lo necesita en otro momento.

Índice

1. Información importante 10
 1.4. Contenido del suministro. 60
 1.5. Datos técnicos 60
 2. Manejo 61
 2.5. Destrucción de papel 62
 2.8. Sobrecarga (overload). 63
 2.10. Sobrecalentamiento (overheat) 64
 2.11. Destrucción de CD/DVD y tarjetas. 65
 3. Mantenimiento. 66
 3.1 Vaciado de material cortado. 66
 3.3 Posibles fallos 66
 3.4 Limpieza del aparato 66

1.1. Utilización conforme al uso prescrito, garantía

La destructora está diseñada para la destrucción de papel.
 La garantía no cubre el desgaste, los daños causados por uso indebido ni las consecuencias de una manipulación por parte de terceros.
 La destructora no está diseñada para ser utilizada en entornos industriales.







1.2. Indicaciones de seguridad

- No colocar el aparato cerca de ninguna fuente de calor.
- Almacenar, transportar y utilizar el aparato exclusivamente en posición vertical.
- Aplicar a la destructora exclusivamente líquidos y gases que cumplan las especificaciones de DAHLE.
- No abrir el aparato.













- Utilizar el aparato exclusivamente en lugares cerrados, a una temperatura entre 10°C y 25°C y con una humedad ambiental no condensante entre el 15% y el 95%.
- La instalación eléctrica del edificio debe estar protegida contra cortocircuitos (máx. 20 A).
- El aparato nunca debe funcionar en vacío.
- Utilizar una sola ranura de alimentación en cada operación

 **Desear la destructora debidamente en un punto limpio autorizado y cumpliendo la normativa medioambiental. No deseche ninguna parte de la destructora ni del embalaje con la basura doméstica.**

1.3. Significado de los pictogramas

-  Información importante
-  Leer atentamente la información para el usuario y las indicaciones de seguridad
-  **ATENCIÓN**
Colocar el aparato en el suelo y en posición vertical estable, a una distancia de 100 mm de la pared, evitando que se acumule el calor, accionar los frenos inmovilizadores (en determinados modelos)
-  No utilizar cerca de sustancias corrosivas.
-  No utilizar cerca de líquidos o gases inflamables.
-  Inicio automático

-  Evitar que el aparato se moje.
-  Esta destructora no está destinada para ser utilizada por niños (este producto no es un juguete).
-  No tocar el alimentador de papel.
-  Evitar que la ropa entre en contacto con el alimentador de papel.
-  No aproximar el cabello al alimentador de papel.
-  No aproximar botes de espray.
-  Antes de destruir papel, retirar todos los clips y grapas que pueda llevar.
-  No introducir disquetes.
-  Antes de realizar cualquier trabajo de mantenimiento, desconectar la destructora de la red eléctrica.
-  Datos técnicos - ¡Sujeto a modificaciones técnicas sin previo aviso!
-  Emisión de ruido durante el funcionamiento
-  Corte de papel en partículas
-  Corte de discos CD/DVD en tiras

-  Corte de tarjetas en tiras
-  Peso
-  La clavija de red actúa como dispositivo desconector de la alimentación eléctrica.
-  El enchufe debe estar fácilmente accesible en todo momento.
-  Manejo
-  Destruidora lista para ser utilizada
-  Destruidora en funcionamiento
-  Desconexión automática.
-  En caso de sobrecarga o de un uso excesivo, la destructora se apaga automáticamente para enfriarse.
-  Consejos de mantenimiento y resolución de problemas
-  Depósito lleno
-  Posibles averías
-  El aparato se desconecta automáticamente cuando se abre la carcasa.

IT Traduzione dal manuale d'uso originale

ATTENZIONE!
PRIMA della messa in funzione della distruggidocumenti, leggere attentamente il manuale d'uso e le istruzioni di sicurezza. Le istruzioni devono essere applicate! Conservare il manuale d'uso per l'utilizzo successivo..

Indice

1. Informazioni importanti 12
 1.4. Volume di fornitura 60
 1.5. Dati tecnici 60
 2. Utilizzo 61
 2.5. Distruzione carta 62
 2.8. Sovraccarico (overload) 63
 2.10. Surriscaldamento (overheat) 64
 2.11. Distruzione CD/DVD e carte plastificate .. 65
 3. Manutenzione 66
 3.1. Svuotamento ritagli 66
 3.3. Possibili guasti/anomalie 66
 3.4. Pulizia apparecchio 66

1.1. Utilizzo conforme, garanzia

La distruggidocumenti è destinata alla distruzione di carta.
 La garanzia non comprende l'usura, i danni da utilizzo non conforme nonché gli interventi da parte di terzi.
 La distruggidocumenti non è adatta all'uso industriale.







1.2. Istruzioni di sicurezza



























- Non posizionare l'apparecchio in prossimità di fonti di calore!
- Utilizzare, riporre e trasportare l'apparecchio esclusivamente in posizione verticale!
- Sull'apparecchio utilizzare solo sostanze liquide o gassose conformi alle direttive DAHLE!
- Non aprire l'apparecchio!
- È necessario garantire che l'impianto dell'edificio sia protetto dai cortocircuiti (max. 20 A).

- Utilizzare l'apparecchio solo in ambienti chiusi a una temperatura compresa tra i 10 °C e i 25 °C e un'umidità dell'aria senza condensa del 15-95%!
- Non utilizzare l'apparecchio a vuoto!
- Utilizzare i cassettoni di alimentazione uno per volta!!

 **La distruggidocumenti deve essere smaltita in conformità con le norme vigenti in materia di tutela dell'ambiente presso un centro di raccolta autorizzato. Non gettare alcun componente della distruggidocumenti o dell'imballaggio nei rifiuti domestici.**

1.3. Leggenda pittogramma

-  Informazioni importanti
-  Leggere le informazioni utente e le istruzioni di sicurezza
-  **ATTENZIONE**
-  Posizionare l'apparecchio sul pavimento e a una distanza di 100 mm dalla parete, evitare ristagni di calore, azionare i freni di blocco (a seconda del modello)
-  Non utilizzare in prossimità di sostanze corrosive.
-  Non utilizzare in prossimità di liquidi o gas infiammabili.
-  Avvio automatico

-  Non esporre all'umidità
-  L'apparecchio non è destinato all'uso da parte dei bambini (il prodotto non è un giocattolo).
-  Non toccare l'alimentatore della carta con le mani.
-  Assicurarsi che gli abiti non tocchino l'alimentatore della carta!
-  Non toccare l'alimentatore della carta con i capelli!
-  Tenere lontano da bombolette spray!
-  Prima di distruggere i documenti, rimuovere punti e graffette!
-  Non inserire dischetti!
-  Prima degli interventi di manutenzione, staccare la presa della distruggidocumenti!
-  Dati tecnici – Si riserva la facoltà di apportare modifiche tecniche!
-  Rumorosità in esercizio a vuoto
-  Taglio carta a particelle
-  Taglio CD/DVD a strisce
-  Taglio carte plastificate a strisce
-  Peso
-  La spina funge da separatore dell'alimentazione di corrente.
-  La presa di corrente deve essere sempre facilmente accessibile!
-  Utilizzo
-  Distruggidocumenti in standby
-  Distruggidocumenti in esercizio
-  Spegnimento automatico!
-  Dopo un periodo di esercizio prolungato e/o sovraccarico la distruggidocumenti si spegne automaticamente per garantire il raffreddamento.
-  Istruzioni per la manutenzione/ Risoluzione delle anomalie
-  Recipiente pieno
-  Possibili guasti/anomalie
-  Spegnimento automatico in caso di cassetto aperto

PT Tradução do manual de utilização original

ATENÇÃO!
 ANTES de colocar a trituradora de papel funcionamento, ler cuidadosamente o manual de utilização e as indicações de segurança.
 As indicações devem ser respeitadas!
 Guarde o manual de utilização para uso futuro.

Índice

1. Informações importantes. 14
 1.4. Âmbito de fornecimento 60
 1.5. Dados técnicos 60
 2. Operação. 61
 2.5. Destruição de papel 62
 2.8. Sobrecarga (overload). 63
 2.10. Sobreaquecimento (overheat) 64
 2.11. Destruição de CDs/DVDs e cartões 65
 3. Manutenção. 66
 3.1. Esvaziar os resíduos de papel. 66
 3.3. Possíveis avarias 66
 3.4. Limpar o aparelho 66

1.1. Utilização correta, garantia

Esta trituradora de papel destina-se à trituração de papel. Desgaste, danos provocados por uma utilização incorreta, assim como intervenções de terceiros não estão abrangidos pela garantia, nem o fabricante assume qualquer responsabilidade pelos mesmos.
 Esta trituradora de papel não se destina ao uso industrial.

1.2. Indicações de segurança



- Não colocar o aparelho perto de uma fonte de calor!
- Armazenar, transportar ou utilizar o aparelho exclusivamente na vertical!
- Utilizar no aparelho apenas líquidos e gases que correspondam às diretivas DAHLE!
- Não abrir o aparelho!
- O aparelho deve ser operado exclusivamente em espaços





fechados, a uma temperatura entre os 10 °C a 25 °C e uma humidade atmosférica não condensada de 15 % a 95 %!

























- Providenciar a proteção contra curto-circuito na instalações do edifício (máx. 20 A)!
- Não utilizar o aparelho em vazio!
- Utilizar as ranhuras de alimentação apenas individualmente!

 **Elimine a trituradora de papel de forma adequada e compatível com o meio ambiente num ponto de recolha autorizado. Não coloque nenhuma peça da trituradora de papel ou a embalagem no lixo doméstico.**

1.3. Legenda dos pictogramas

-  Informações importantes
-  Ler as informações ao utilizador/indicações de segurança

-  **ATENÇÃO**
 Pousar o aparelho de forma estável no chão e com uma distância de 100 mm da parede. Evitar a acumulação de calor.
 Aconionar os travões de fixação (consoante o modelo)
-  Não utilizar junto de materiais ácidos.
-  Não utilizar junto de líquidos ou gases inflamáveis.
-  Iniciação automática

-  Não expor à humidade.
-  Esta trituradora de papel não se destina a ser utilizada por crianças (o produto não é nenhum brinquedo).
-  Não toque com as mãos na alimentação do papel.
-  Não toque com a roupa na alimentação do papel!
-  Não toque com os cabelos na alimentação do papel!
-  Mantenha latas de aerossol afastadas do dispositivo!
-  Remover agramos e cliques antes do processo de trituração!
-  Não inserir disquetes!
-  Antes dos trabalhos de manutenção, desligar a trituradora de papel da rede elétrica!
-  Dados técnicos – Sujeito a alterações técnicas!
-  Volume de funcionamento em vazio
-  Corte de papel em partículas
-  Corte de CDs/DVDs em tiras
-  Corte de cartões em tiras
-  Peso
-  A ficha serve de dispositivo separador da alimentação de energia.
-  A tomada de rede deve estar sempre acessível!
-  Operação
-  Trituradora de papel operacional
-  Trituradora de papel em funcionamento
-  Desativação automática!
-  Após um funcionamento prolongado e/ou sobrecarga, a trituradora de papel desliga-se automaticamente para arrefecer.
-  Indicações de manutenção/eliminação de avarias
-  Recipiente cheio
-  Possíveis avarias
-  Desativação automática no caso de abertura da caixa

NL Vertaling van de originele handleiding

OPGELET!
 VOOR u de papiervernietiger gebruikt, moet u aandachtig de handleiding en veiligheidsaanwijzingen lezen!
 Volg alle veiligheidsvoorschriften!
 Bewaar de handleiding voor later gebruik.

Inhoudsopgave

1.	Belangrijke informatie.	16
1.4.	Leveringsomvang	60
1.5.	Technische gegevens.	60
2.	Bediening	61
2.5.	Papiervernietiging	62
2.8.	Overbelasting (overload).	63
2.10.	Oververhitting (overhead).	64
2.11.	CD/DVD-, kaartvernietiging	65
3.	Onderhoud	66
3.1	Versnipperd materiaal verwijderen	66
3.3	Mogelijke storingen	66
3.4	Apparaat reinigen.	66

1.1. Bedoeld gebruik, garantieaanspraak

Deze papiervernietiger is bedoeld voor het versnipperen van papier.
 Slijtage of schade door onjuist gebruik vallen net als ingrepen van derden noch onder de garantieaanspraak, noch onder de garantie.
 Deze papiervernietiger is niet bedoeld voor industrieel gebruik.

1.2. Veiligheidsaanwijzingen

- Het apparaat niet in de nabijheid van warmtebronnen opstellen!
- Het apparaat uitsluitend rechtop staand bewaren, transporteren en gebruiken!
- Gebruik voor het apparaat uitsluitend vloeistoffen en gassen die aan de DAHLE-richtlijnen voldoen!
- Het apparaat mag niet worden geopend!

- Het apparaat alleen gebruiken in gesloten ruimtes met een omgevingstemperatuur van 10 °C tot 25 °C en een niet-condenserende luchtvochtigheid van 15 % tot 95 %!
- Zorg voor een kortsluitingsbeveiliging die is aangesloten op de installatie van het gebouw (max. 20A).
- Het apparaat niet leeg gebruiken!
- Gebruik invoerlades uitsluitend afzonderlijk!

 **Lever voor een milieuvriendelijke en vakkundige afvalverwerking de papiervernietiger in bij een bevoegd verwerkingsbedrijf. Zet geen delen van de papiervernietiger of het verpakkingsmateriaal bij het huisvuil.**

1.3. Legende van pictogrammen

-  Belangrijke informatie
-  Gebruikersinformatie/veiligheidsaanwijzingen lezen
-  Waarschuwing
-  Zet het apparaat op een stabiele ondergrond op minstens 10 cm van de muur. Voorkom warmteaccumulatie.
-  Vastzetremmen gebruiken (modelafhankelijk)
-  Niet gebruiken in de nabijheid van agressieve stoffen.
-  Niet gebruiken in de nabijheid van ontvlambare vloeistoffen of gassen.
-  Automatische start

-  Niet aan vochtigheid blootstellen.
-  Deze papiervernietiger is niet bedoeld voor gebruik door kinderen (dit product is geen speelgoed).
-  Raak de papierinvoeropening niet aan met uw handen.
-  Houd kledingstukken uit de buurt van de papierinvoeropening!
-  Blijf met uw haar uit de nabijheid van de papierinvoeropening!
-  Houd spuitbussen uit de buurt van de papiervernietiger!
-  Voor men papier versnipperd, moet men paperclips en nietjes verwijderen!
-  Geen diskettes invoeren!
-  Alvorens onderhoudswerkzaamheden aan de papiervernietiger uit te voeren, moet men de stekker uit het stopcontact halen!
-  Technische gegevens - technische wijzigingen onder voorbehoud!
-  Werkingsgeluidsterkte bij onbelast gebruik
-  Papiersnipperers snijden
-  CD/DVD-stroken snijden

-  Kaartstroken snijden
-  Gewicht
-  De stroomstekker dient als ontkoppelinrichting van de stroomvoorziening.
-  Het stopcontact moet op elk moment gemakkelijk toegankelijk zijn!
-  Bediening
-  Papiervernietiger gereed
-  Papiervernietiger in bedrijf
-  Automatische uitschakeling!
-  Bij langdurig gebruik en/of overbelasting wordt de papiervernietiger voor afkoeling automatisch uitgeschakeld.
-  Onderhoudsaanwijzingen/storingen verhelpen
-  Opvangbak vol
-  Mogelijke storingen
-  Automatische uitschakeling bij open behuizing

DK Oversættelse af den originale betjeningsvejledning

- GIV AGT!**
Læs betjeningsvejledningen og sikkerhedsanvisningerne til makulatorens nøje, FØR den tages i brug.
Anvisningerne skal følges!
Opbevar betjeningsvejledningen til senere anvendelse.

Indholdsfortegnelse

1.	Vigtige oplysninger	18
1.4.	Leveringsomfang	60
1.5.	Tekniske data	60
2.	Betjening	61
2.5.	Papirmakulering	62
2.8.	Overbelastning (overload)	63
2.10.	Overophedning (overhead)	64
2.11.	Makulering af cd'er/dvd'er og kort	65
3.	Vedligeholdelse	66
3.1	Tømning af opsamlingsbeholderen	66
3.3	Mulige fejl	66
3.4	Rensning af apparatet	66

1.1. Tilsigtet anvendelse, garanti

Denne makulator er beregnet til makulering af papir. Slitage, skader pga. uheldsmæssig brug samt indgreb foretaget af tredjeparter falder hverken ind under kvalitetsgarantien eller garantien.
Denne makulator er ikke beregnet til industriel anvendelse.



1.2. Sikkerhedsanvisninger

- Apparatet må ikke opstilles i nærheden af en varmekilde!
- Apparatet må kun opbevares, transporteres og anvendes opretstående!
- Brug kun væsker og gasser ved apparatet som opfylder retningslinjerne fra DAHLE.
- Apparatet må ikke åbnes!
- Apparatet må kun anvendes i lukkede rum ved en

























temperatur på 10-25 °C og med en relativ luftfugtighed på 15-95 % uden kondensering!
- Kontroller, at strømforsyningen er sikret på bygningssiden (maks. 20 A).
- Lad ikke apparatet køre i tomgang!
- Indføringsåbningerne må kun anvendes enkeltvis!

 **Makulatorens skal bortskaffes på fagligt og miljømæssigt forsvarlig vis på en autoriseret genbrugsplads. Ingen del af makulatorens eller indpakningen må bortskaffes sammen med husholdningsaffald.**

1.3. Forklaring af symboler

-  Vigtige oplysninger
-  Læs brugeroplysninger/sikkerhedsanvisninger

-  **GIV AGT!**
Makulatorens skal opstilles, så den står sikkert på gulvet, og i en afstand på 100 mm fra væggen, så varmen kan slippe væk. Aktiver fastgøringsbremserne (afhænger af typen)
-  Må ikke anvendes i nærheden af ætsende stoffer.
-  Må ikke anvendes i nærheden af brandbare væsker og gasser.
-  Automatisk start

-  Må ikke udsættes for fugt.
-  Denne makulator er ikke beregnet til at blive brugt af børn (produktet er ikke legetøj).
-  Rør ikke ved papirtilførslen med hænderne.
-  Rør ikke ved papirtilførslen med beklædningsgenstande!
-  Rør ikke ved papirtilførslen med håret!
-  Hold spraydåser fjernt fra apparatet!
-  Fjern klips og hæfteklammer før makulering!
-  Sæt ikke disketter i!
-  Før der foretages vedligeholdelse af makulatorens, skal der slukkes for strømtilførslen!
-  Tekniske data - Forbeholdt tekniske ændringer!
-  Lydniveau i tomgang
-  Papir-partikelsnit
-  Cd/dvd-strimmelsnit
-  Kort-strimmelsnit
-  Vægt
-  Stik tjener som skilleanordning i strømforsyningen.
-  Stikdåsen til lysnettet skal altid være let tilgængelig!
-  Betjening
-  Makulator i stand-by
-  Makulator i drift
-  Automatisk slukning!
-  Makulatorens slukker automatisk efter længere tids drift og/eller overbelastning for at køle af.
-  Vedligeholdelsesanvisninger/afhjælpning af fejl
-  Opsamlingsbeholderen er fuld
-  Mulige fejl
-  Automatisk slukning ved åbent kabinet

FI Käännös alkuperäisestä käyttöohjeesta

HUOMIO!
Lue käyttö- ja turvallisuusohjeet huolellisesti ENNEN asiakirjasilppurin käyttöön-ottoa!
Ohjeita on noudatettava!
Säilytä käyttöohje myöhempiä käyttöä varten.

Sisällys

1. Tärkeitä tietoja 20
1.4. Toimituksen sisältö 60
1.5. Tekniset tiedot 60
2. Käyttö 61
2.5. Paperin silppuaminen 62
2.8. Ylikuormitus (overload) 63
2.10. Ylikuumentuminen (overheat) 64
2.11. CD/DVD-levyjien, korttien silppuaminen . . . 65
3. Huolto 66
3.1 Silpun poistaminen 66
3.3 Mahdolliset häiriöt 66
3.4 Laitteen puhdistaminen 66

1.1. Tarkoituksenmukainen käyttö, tuotevastuu

Tämä asiakirjasilppuri on tarkoitettu paperin silppuamiseen.
Kulutus, epäasianmukaisesta käytöstä johtuvat vauriot ja ulkopuolisen toimenpiteet eivät kuulu tuotevastuun eivätkä takuun piiriin.
Tämä asiakirjasilppuri ei sovellu teollisuuskäyttöön.

1.2. Turvallisuusohjeet

- Älä aseta laitetta lämmönlähteen lähelle!
- Säilytä, kuljeta ja käytä laitetta ainoastaan pystyasennossa!
- Käytä laitteessa vain nesteitä ja kaasuja, jotka täyttävät DAHLEN vaatimukset!
- Käytä laitetta ainoastaan suljetuissa tiloissa 10–25 °C:ssa ja tiivistymättömässä 15–95 %:n ilmastokosteudessa!

- Laitetta ei saa avata!
- Varmista rakennuksen oikosulkusuoja (maks. 20 A).
- Älä käytä laitetta tyhjänä!
- Käytä vetokäytäviä vain yksittäin!

Hävitä asiakirjasilppuri ammattimaisesti ja ympäristöystävällisesti valtuutetussa keräyspisteessä. Asiakirjasilppurin osia tai pakkausta ei saa laittaa talousjätteen sekaan.

1.3. Merkkien selitykset

- Tärkeä tieto
- Tietoa käyttäjälle/lue turvallisuusohjeet
- HUOMIO**
- Aseta laite tukevasti lattialle 100 mm:n etäisyydelle seinästä, vältä kuumentumista suman vuoksi, lukitse seisontajarrut (mallista riippuvainen)
- Asiakirjasilppuria ei saa käyttää syövyttävien aineiden läheisyydessä.
- Asiakirjasilppuria ei saa käyttää palavien nesteiden tai kaasujen läheisyydessä.
- Automaattinen käynnistys
- Ei saa altistua kosteudelle

- Tämä asiakirjasilppuri ei sovellu lasten käyttöön (laite ei ole leikkikalu).
- Paperinsyöttöön ei saa koskea käsin.
- Paperinsyöttöön ei saa laittaa vaatekapaleita!
- Paperinsyöttöön ei saa laittaa hiuksia!
- Pidä spraypullot kaukana!
- Paperiliittimet ja niitit on poistettava ennen silppuamista!
- Älä syötä diskettejä!
- Irrota asiakirjasilppuri virtalähteestä ennen huoltotöitä!
- Tekniset tiedot – Oikeudet teknisiin muutoksiin pidätetään!
- Äänenvoimakkuus tyhjäkäynnissä
- Paperin silppuleikkaus
- CD/DVD-levyjien suikaleikkaus
- Korttien suikaleikkaus

- Paino
- Verkkopistoke toimii virtalähteen katkaisijana.
- Verkkopistorasia on oltava aina helposti tavoitettavissa!
- Käyttö
- Asiakirjasilppuri valmiustilassa
- Asiakirjasilppuri toiminnassa
- Automaattinen sammutus!
- Pidempiaikaisessa käytössä ja/tai ylikuormituksen vuoksi asiakirjasilppuri kytkeytyy automaattisesti pois päältä jäähtymään.
- Huolto-ohjeet/häiriöiden korjaus
- Silppusäiliö täynnä
- Mahdolliset häiriöt
- Automaattinen sammutus avatulla kotelolla

NO Oversettelse av den opprinnelige bruksanvisningen

OBS!
FØR du tar i bruk makuleringsmaskinen må du lese nøye gjennom bruksanvisningen og sikkerhetsinstruksene.
Anvisningene må anvendes!
Oppbevar bruksanvisningen for senere bruk.

Innholdsfortegnelse

1.	Viktig informasjon	22
1.4.	Leveringsomfang	60
1.5.	Tekniske data	60
2.	Betjening	61
2.5.	Makulering av papir	62
2.8.	Overlastet (overload)	63
2.10.	Overopphetet (overheat)	64
2.11.	CD/DVD-, kortmakulering	65
3.	Vedlikehold	66
3.1	Tømme skjæregods	66
3.3	Mulige feil	66
3.4	Rengjøre apparatet	66

1.1. Forskriftsmessig bruk, garanti

Denne makuleringsmaskinen er ment til makulering av papir.
Slitasje og skader grunnet feilaktig bruk og inngrep av tredje, faller verken under ansvar eller garanti.
Denn makuleringsmaskinen er ikke egnet til industriell bruk.







1.2. Sikkerhetsinstrukser

- Apparatet må ikke plasseres i nærheten av en varmekilde!
- Apparatet må kun lagres, transporteres og brukes stående!
- Man må kun benytte væsker og gass som tilsvarer DAHLE-direktivene på apparatet!
- Apparatet skal ikke åpnes!
- Ikke la apparatet gå på tomgang!

- Apparatet må kun drives i et lukket rom med en temperatur på 10 °C til 25 °C og en ikke-kondenserende luftfuktighet på 15 % til 95 %!
- Man må forsikre seg om at bygningsinstallasjonen er kortslutningssikker (maks. 20 A).
- Matekanaler må kun brukes enkeltvis!

 **Makuleringsmaskinen må kastes faglig korrekt og miljøvennlig ved et autorisert samlested for avfall. Ingen deler av makuleringsmaskinen eller emballasjen får kastes i husholdningsavfallet.**

1.3. Piktogramlegende

-  Viktig informasjon
-  Les brukerinformatjonen/sikkerhetsinstruksene
-  **OBS**
Apparatet må plasseres stabilt på gulvet med en avstand på 100 mm til veggen, unngå oppvarming på grunn av kjø/blokking, Betjen parkeringsbremsen (type-avhengig)
-  Må ikke benyttes i nærheten av etsende stoffer.
-  Må ikke benyttes i nærheten av brennbare væsker eller gass.
-  Automatisk start

-  Må ikke utsettes for fuktighet
-  Denne makuleringsmaskinen er ikke ment til bruk av barn (produktet er ikke et leketøy).
-  Ikke berør papirinntaket med hendene.
-  Ikke berør papirinntaket med klesplagg!
-  Ikke berør papirinntaket med hårene!
-  Spraybokser må holdes unna!
-  Fjern binders og heftestifter før makulering!
-  Ikke før inn disketter!
-  Før vedlikeholdsarbeid må makuleringsmaskinen kobles fra strømmettet!
-  Tekniske data - Forbehold om tekniske endringer!
-  Driftslydstyrke på tomgang
-  Papir-partikkelsnitt
-  CD/DVD-stripesnitt
-  Kort-stripesnitt
-  Vekt
-  Strømkontakten brukes som skilleanordning for strømforsyningen.
-  Stikkkontakten må til enhver tid være lett tilgjengelig!
-  Betjening
-  Makuleringsmaskin i beredskap
-  Makuleringsmaskin i drift
-  Automatisk utkobling!
-  Ved lengre drift og/eller overbelastning slås makuleringsmaskinen automatisk av for avkjøling.
-  Vedlikeholdsinstrukser/feilretting
-  Beholder full
-  Mulige feil
-  automatisk utkobling ved åpent hus

SE Översättning ur originalbruksanvisningen

OBS!
Läs uppmärksamt igenom bruksanvisningen och säkerhetsanvisningarna INNAN dokumentförstöraren tas i drift.
Anvisningarna måste tillämpas!
Förvara bruksanvisningen för senare användning.

Innehållsförteckning

1.	Viktig information	24
1.4.	Leveransens omfattning	60
1.5.	Tekniska data	60
2.	Manövrering	61
2.5.	Förstörelse av papper	62
2.8.	Överladdning (overload)	63
2.10.	Överhettning (overheat)	64
2.11.	Förstörelse av CD/DVD-skivor och kort	65
3.	Underhåll	66
3.1	Tömning av skuret material	66
3.3	Möjliga störningar	66
3.4	Rengöring av apparaten	66

1.1. Ändamålsenlig användning, garanti

Den här dokumentförstöraren är avsedd för förstörelse av papper.

Slitage, skador pga. felaktig användning samt ingrepp genom tredje part faller varken under den lagstadgade garantin eller tillverkarens garanti.

Den här dokumentförstöraren är inte lämplig för industriell användning.

1.2. Säkerhetsanvisningar

- Ställ inte upp apparaten i närheten av en värmekälla!
- Förvara, transportera och använd apparaten endast stående!
- Använd endast vätskor och gaser på apparaten som motsvarar DAHLE-riktlinjerna!
- Apparaten får inte öppnas!

- Använd endast apparaten inomhus, vid 10 °C till 25 °C och en ej kondenserande luftfuktighet på 15 % till 95 %!
- Husinstallationens kortslutningssäkerhet måste säkerställas (max. 20 A).
- Använd inte apparaten på tomgång!
- Använd endast inmatningsfacken separat!

 **Avfallshandtera dokumentförstöraren korrekt och miljöriktigt hos ett auktoriserat uppsamlingsställe. Kasta in några delar av dokumentförstöraren eller förpackningen i hushållssoporna.**

1.3. Piktogramförklaring

 Viktig information

 Läs användarinformationen/säkerhetsanvisningarna

 **OBS!**

 Placera apparaten stabilt på golvet och med 100 mm avstånd till väggen, undvik värmeackumulering, använd parkeringsbromsen (typberoende)

 Använd inte apparaten i närheten av frätande ämnen.

 Använd inte apparaten i närheten av brännbara vätskor eller gaser.

 Automatisk start

 Utsätt inte apparaten för väta.

 Denna dokumentförstörare får inte användas av barn (produkten är ingen leksak)!

 Vidrör inte pappersinmatningen med händerna.

 Vidrör inte pappersinmatningen med klädesplagg!

 Vidrör inte pappersinmatningen med håret!

 Håll sprayburkar på avstånd!

 Ta bort gem och häftklammer före förstörelseprocessen!

 Lägg inte in några disketter!

 Koppla bort dokumentförstöraren från elnätet innan underhållsarbete påbörjas!

 Tekniska data - Med reservation för tekniska ändringar!

 Driftsljudnivå på tomgång

 Papper partikelsnitt

 CD/DVD strimlor

 Kort strimlor

 Vikt

 Stickkontakten fungerar som frånskiljningsanordning för strömförsörjningen.

 Nätuttaget måste alltid vara lättåtkomligt!

 Manövrering

 Dokumentförstöraren i beredskap

 Dokumentförstöraren i drift

 Automatisk avstängning!

 Vid längre drift och/eller överbelastning stängs dokumentförstöraren automatiskt av för att svalna.

 Underhållsanvisningar/åtgärder vid störningar

 Behållaren full

 Möjliga störningar

 automatisk frånkoppling vid öppet hölje

SI Prevod originalnega navodila za uporabo



POZOR!

PRED začetkom uporabe uničevalnika dokumentov pozorno preberite navodilo za uporabo in varnostne napotke.



Napotke morate upoštevati!

Navodilo za uporabo shranite za poznejšo uporabo.

Kazalo vsebine

1.	Pomembne informacije	26
1.4.	Obseg dobave	60
1.5.	Tehnični podatki	60
2.	Upravljanje	61
2.5.	Uničevanje papirja	62
2.8.	Preobremenitev (overload).....	63
2.10.	Pregrevanje (overheat).....	64
2.11.	Uničevanje CD/DVD, kartic.....	65
3.	Vzdrževanje.....	66
3.1	Odstranitev razrezanega materiala	66
3.3	Možne motnje	66
3.4	Čiščenje naprave.....	66

1.1. Namenska uporaba, jamstvo

Uničevalnik dokumentov je namenjen za uničevanje papirja.

Obraba, škoda zaradi nepravilne uporabe ter posegi tretjih oseb niso zajeti ne v jamstvu ne v garanciji.

Uničevalnik dokumentov ni primeren za industrijsko uporabo.

1.2. SVarnostni napotki

- Naprave ne postavljajte v bližino virov toplote.
- Napravo skladiščite, transportirajte in uporabljajte izključno v pokončnem položaju!
- Na napravi uporabljajte samo tekočine in pline, ki ustrezajo smernicam podjetja DAHLE!
- Naprave ne smete odpirati!
- Zagotoviti morate zaščito pred kratkim stikom napeljav v zgradbi (maks. 20 A).

- Napravo uporabljajte samo v zaprtih prostorih pri temperaturi od 10 °C do 25 °C in pri nekondenzirani zračni vlažnosti od 15 % do 95 %!
- Naprava ne sme obratovati v prostem teku!
- Podajalne reže uporabljajte le posamično!



Uničevalnik dokumentov strokovno in okolju prijazno odvrzite med odpadke na pooblaščenem zbirnem mestu. Delov uničevalnika dokumentov ali embalaže ne mečite med hišne odpadke.

1.3. Legenda piktogramov



Pomembne informacije



Preberite uporabniške informacije/varnostne napotke



POZOR



Napravo postavite na tla v stabilen položaj 100 mm od stene, preprečite zadrževanje toplote, pritegnite fiksne zavore (odvisno od tipa)



Ne uporabljajte v bližini jedkih snovi.



Ne uporabljajte v bližini gorljivih tekočin ali plinov.



Avtomatski zagon



Ne izpostavljajte vlagi.



Tega uničevalnika dokumentov ne smejo uporabljati otroci (izdelek ni igrača).



Dovoda papirja se ne dotikajte z rokami.



Dovoda papirja se ne dotikajte z oblačili!



Dovoda papirja se ne dotikajte z lasmi!



Razpršilnike držite proč od naprave!



Pred uničevanjem dokumentov z njih odstranite vse sponke!



Ne vstavljajte disket!



Pred vzdrževalnimi deli uničevalnik dokumentov odklopite od električnega napajanja!



Tehnični podatki - pridržujemo si pravico do tehničnih sprememb!



Obratovalna glasnost v prostem teku

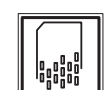

Rezanje papirja na delce



Rezanje CD/DVD na trakove



Rezanje kartic na trakove



Teža



Omrežni vtič služi kot ločilna priprava električnega napajanja.



Omrežna vtičnica mora biti vedno lahko dostopna!



Upravljanje



Uničevalnik dokumentov v pripravljenosti



Uničevalnik dokumentov v obratovanju



Avtomatski izklop!

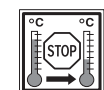

Pri dolgotrajnem obratovanju in/ali preobremenitvi se uničevalnik dokumentov avtomatsko izklopi, da se ohladi.



Navodila za vzdrževanje / odpravljanje napak



Posoda je polna



Možne motnje



avtomatski izklop pri odprtem ohišju

HR Prijevod originalnih uputa za uporabu



PAŽNJA!

PRIJE prve uporabe uništavača dokumenata pažljivo pročitate Upute za uporabu i sigurnosne napomene i pridržavajte ih se!
Obavezno poštujujte sve napomene!
Sačuvajte ove upute za kasniju uporabu.

Sadržaj

1.	Važne informacije.....	28
1.4.	Opseg isporuke.....	60
1.5.	Tehnički podaci.....	60
2.	Uporaba.....	61
2.5.	Uništavanje dokumenata.....	62
2.8.	Preopterećenje (overload).....	63
2.10.	Pregrijavanje (overheat).....	64
2.11.	Uništavanje CD-a, DVD-a, kartica.....	65
3.	Održavanje.....	66
3.1.	Pražnjenje odrezaka.....	66
3.3.	Moguće smetnje.....	66
3.4.	Čišćenje stroja.....	66

1.1. Namjenska uporaba, jamstvo

Ovaj uništavač dokumenata namijenjen je uništavanju papira.

Trošenje, oštećenja zbog neprikladne uporabe i zahvati koje izvrši treća strana nisu obuhvaćeni ni jamstvom ni garancijom.

Ovaj uništavač dokumenata nije prikladan za uporabu u industriji.



1.2. Sigurnosne upute

- Nemojte uređaj postaviti u blizini izvora topline!
- Ovaj stroj skladištite, prevozite i koristite isključivo u uspravnom položaju!
- Prilikom rada stroja koristite samo tekućine i plinove koji ispunjavaju zahtjeve iz smjernica tvrtke DAHLE!
- Uređaj se ne smije otvarati!
- Stroj ne smije raditi u praznom hodu!



























- Ovaj stroj koristite isključivo u zatvorenim prostorima na temperaturi od 10 °C do 25 °C i na vlažnosti bez kondenzacije od 15 % do 95 %!
- Instalacije unutar zgrade moraju obavezno biti napravljene tako da su sigurne od kratkog spoja (maks. 20 A).
- Otvore za uvlačenje koristiti samo pojedinačno!

 **Uništavač dokumenata zbrinite stručno i u skladu s propisima o zaštiti okoliša na ovlaštenom deponiju. Dijelove uništavača dokumenata ili ambalaže ne odlažite u kućanski otpad.**

1.3. Legenda pitkograma

-  Važne informacije
-  Pročitajte korisničke informacije/sigurnosne napomene

-  **PAŽNJA**
-  Stroj postavite na čvrsto tlo na udaljenosti 100 mm od zida i izbjegavajte gomilanje topline! Aktivirajte kočnice za zaustavljanje (ovisno o tipu)
-  Uređaj nemojte koristiti u blizini korozivnih tvari.
-  Uređaj nemojte koristiti u blizini zapaljivih tekućina ili plinova.
-  Automatsko pokretanje uređaja

-  Uređaj nemojte izlagati vlazi
-  Ovim uništavačem dokumenata ne smiju rukovati djeca (proizvod nije igračka).
-  Otvor za ulaganje papira nemojte dodirivati rukama.
-  Otvor za ulaganje papira ne dodirujte komadima odjeće!
-  Otvor za ulaganje papira ne dodirujte kosom!
-  Držite podalje od sprejeva!
-  Prije uništavanja dokumenata ukloniti spajalice i klamerice!
-  Nemojte uvoditi diskete!
-  Prije radova održavanja isključite uništavač dokumenata iz napajanja strujom!
-  Tehnički podaci - Pridržano pravo tehničkih izmjena!
-  Razina buke pri radu u praznom hodu
-  Rezanje papira u sitne dijelove
-  Rezanje CD-a/DVD-a u trake
-  Rezanje kartica u trake
-  Masa
-  Utikač služi za odvajanje električnog napajanja
-  Mrežna utičnica mora uvijek biti lako pristupačna!
-  Uporaba
-  Uništavač dokumenata u stanju pripravnosti
-  Uništavač dokumenata u radu
-  Automatsko isključivanje!
-  Kod dužeg rada i/ili preopterećenja uništavač dokumenata se automatski gasi radi hlađenja.
-  Napomene o održavanju/otklanjanje smetnji
-  Spremnik pun
-  Moguće smetnje
-  automatsko gašenje kod otvorenog kućišta

HU Az eredeti kezelési utasítás fordítása



FIGYELEM!

Az iratmegsemmisítő üzembe helyezése ELŐTT figyelmesen olvassa el a kezelési és biztonsági utasításokat.

Az utasításokat alkalmazni kell.

Őrizze meg a kezelési utasítást a későbbi használatához.

Tartalomjegyzék

1.	Fontos információk	30
1.4.	A csomag tartalma.....	60
1.5.	Műszaki adatok	60
2.	Kezelés.....	61
2.5.	Papírok megsemmisítése	62
2.8.	Túlterhelés (overload).....	63
2.10.	Túlmelegedés (overheat).....	64
2.11.	CD/DVD lemezek és kártyák megsemmisítése ..	65
3.	Karbantartás	66
3.1	Apríték kiürítése	66
3.3	Lehetséges problémák	66
3.4	A készülék tisztítása	66

1.1. Rendeltetés szerinti használat, garancia

Ez az iratmegsemmisítő papírok megsemmisítésére készült.

A kopásból, nem rendeltetés szerű használatból és külső beavatkozásból származó károokra a garancia nem érvényesíthető.

Ez az iratmegsemmisítő nem alkalmas ipari használatra.

1.2. Biztonsági utasítások

- Biztonsági utasítások
- A készüléket nem szabad hőforrások közelében elhelyezni.
- A készülék kizárólag álló helyzetben tárolható, szállítható és üzemeltethető.
- A készülékhez csak olyan folyadékokat és gázokat használjon, amelyek megfelelnek a DAHLE előírásainak.
- A készüléket tilos felnyitni.

- A készüléket kizárólag zárt helyiségekben, 10 és 25 °C közötti hőmérsékleten, kondenzációmentes, 15 és 95% közötti páratartalom mellett üzemeltesse.
- Az épület elektromos hálózatában biztonsági rövidzárlat-védelmet kell felszerelni (max. 20 A).
- Ne működtesse üresen a készüléket.
- A behúzónyílásokat csak egyenként használja.



Az iratmegsemmisítőt szakszerű, környezetbarát módon selejtezze le és adja le egy átvételre jogosult gyűjtőhelyen. Az iratmegsemmisítő vagy a csomagolás semmilyen részét ne helyezze a háztartási hulladék közé.

1.3. Piktogramok magyarázata



Fontos információ



Olvassa el a kezelési/biztonsági utasításokat



FIGYELEM



A készüléket biztonságosan állítsa a taljra a faltól 100 mm távolságra és ne hagyja, hogy a hő felhalmozódjon benne. Nyomja le a rögzítőféket (típusfüggő).



Ne használja maró anyagok környezetében.



Ne használja gyúlékony folyadékok vagy gázok környezetében.



Automatikus indítás



Ne használja nedves környezetben.



A készüléket nem gyermekek általi használatra tervezték (a termék nem játék).



Ne érjen hozzá kézzel a papíradagolóhoz.



Ne érjen hozzá a ruhájával a papíradagolóhoz.



Ne érintse haját a papíradagolóhoz.



Tartsa távol a szóróflakonokat.



Az iratok megsemmisítése előtt távolítsa el belőlük a tűzőkapcsokat és gemkapcsokat.



Ne helyezzen be lemezeket.



A karbantartás előtt válassza le az iratmegsemmisítőt az elektromos hálózatról.



Műszaki adatok – A műszaki változtatások jogát fenntartjuk.



Zajsztint üressjárásban



Papír – keresztvágás



CD/DVD – csíkokra vágás



Kártyák – csíkokra vágás



Tömeg



A hálózati dugó az áramellátás leválasztására szolgál.



A hálózati csatlakozónak mindig könnyen hozzáférhetőnek kell lennie.



Kezelés



Az iratmegsemmisítő használatra kész



Az iratmegsemmisítő működik



Automatikus kikapcsolás!



Az iratmegsemmisítő hosszú használat és/ vagy túlterhelés miatt automatikusan leáll, hogy lehűlhessen.



Karbantartási utasítások/hibaelhárítás



Megtelt a tartály



Lehetséges problémák



Automatikus kikapcsolás nyitott fedélnél

RU Перевод из оригинального руководства по эксплуатации

ВНИМАНИЕ!
 ПЕРЕД вводом в эксплуатацию машины для уничтожения деловых бумаг внимательно прочитайте руководство по эксплуатации и указания по технике безопасности. Строго придерживайтесь указаний! Сохраните руководство по эксплуатации для использования в будущем.

Оглавление

1.	Важная информация	32
1.4.	Комплект поставки	60
1.5.	Технические характеристики	60
2.	Работа с машиной	61
2.5.	Уничтожение бумаг	62
2.8.	Перегрузка (overload)	63
2.10.	Перегрев (overheat)	64
2.11.	Уничтожение CD/DVD-дисков и пластиковых карт	65
3.	Техническое обслуживание	66
3.1	Удаление порезанного материала	66
3.3	Возможные неисправности	66
3.4	Чистка машины	66

1.1. Применение по назначению, гарантийные обязательства

Эта машина предназначена для уничтожения деловых бумаг. Гарантийные обязательства не распространяются на износ и повреждения, вызванные ненадлежащим использованием машины или вмешательством третьих лиц. Машина для уничтожения деловых бумаг не предназначена для промышленного применения

1.2. Указания по технике безопасности

- Указания по технике безопасности
- Не устанавливать машину вблизи источников тепла!
- Машину следует хранить, транспортировать и использовать только в вертикальном положении!
- Возле машины использовать только жидкости и газы, соответствующие директивам компании DAHLE!

- Открывать машину запрещено!
- Использовать машину только в закрытых помещениях при температуре от 10 до 25 °C и влажности воздуха, не способствующей образованию конденсата (от 15 до 95 %)!
- Обеспечить защиту от короткого замыкания проводки в здании (макс. 20 А).
- Не допускать работы машины на холостом ходу!
- Подающие лотки использовать только по отдельности!

 Утилизировать машину для уничтожения бумаг с учетом требований по охране окружающей среды, сдав ее в специализированный пункт сбора отходов. Не выбрасывать детали машины для уничтожения бумаг или компоненты упаковки вместе с бытовыми отходами.

1.3. Объяснение пиктограмм

-  Важная информация
-  Прочитать информацию для пользователя/указания по технике безопасности
-  **ВНИМАНИЕ**
-  Установить машину устойчиво на полу на расстоянии 100 мм от стены, не допускать образования теплового застоя, активировать стопор (в зависимости от типа)
-  Не использовать вблизи едких веществ.
-  Не использовать рядом с воспламеняющимися жидкостями или газами.
-  Автоматический запуск

-  Не подвергать воздействию влаги
-  Данная машина для уничтожения бумаг не предназначена для использования детьми (изделие не является игрушкой).
-  Не прикасаться руками к механизму подачи бумаги.
-  Не допускать контакта одежды с механизмом подачи бумаги!
-  Не допускать контакта волос с механизмом подачи бумаги!
-  Не хранить вблизи машины аэрозольные баллончики!
-  Перед процессом уничтожения снять с бумаги все скрепки и скобы!
-  Не использовать для уничтожения дискет!
-  Перед проведением работ по техническому обслуживанию отключить машину от электропитания!
-  Технические характеристики – Возможны технические изменения!
-  Уровень рабочего шума на холостом ходу
-  Перекрестная резка бумаги
-  Продольная резка CD/DVD-дисков
-  Продольная резка пластиковых карт
-  Масса
-  Сетевой штекер используется для отсоединения от электросети.
-  Обеспечить быстрый доступ к сетевой розетке!
-  Работа с машиной
-  Машина для уничтожения деловых бумаг в состоянии готовности
-  Машина для уничтожения деловых бумаг в рабочем состоянии
-  Автоматическое выключение!
-  При длительной эксплуатации и/или перегрузке машина для уничтожения бумаг автоматически отключается для остывания.
-  Указания по техническому обслуживанию/устранение неисправностей
-  Емкость заполнена
-  Возможные неисправности
-  автоматическое отключение при открывании корпуса

EE Algupärase kasutusjuhendi tõlge



TÄHELEPANU!

Lugege kasutusjuhend ja ohutusjuhised tähelepanelikult ENNE paberipurustaja kasutamist läbi.

Juhistest tuleb kinni pidada!

Hoidke kasutusjuhend hilisemaks kasutamiseks alles.

Sisukord

1.	Tähtis teave	34
1.4.	Pakendi sisu	60
1.5.	Tehnilised andmed	60
2.	Kasutamine	61
2.5.	Paberi purustamine	62
2.8.	Ülekoormus (overload)	63
2.10.	Ülekuumenemine (overheat)	64
2.11.	CD-/DVD-plaatide ja kaartide purustamine	65
3.	Hooldus	66
3.1	Purustatud materjali kõrvaldamine	66
3.3	Võimalikud tõrked	66
3.4	Seadme puhastamine	66

1.1. Sihtotstarbeline kasutamine, garantii

Dokumentide purustaja on mõeldud paberi purustamiseks. Kulumisest, mittesihtotstarbelisest kasutamisest ja ka kolmandate isikute läbiviidud parandustöödest põhjustatud kahjud ei kuulu ei tagatise ega garantii alla.

Dokumentipurustaja ei sobi tööstuslikuks kasutamiseks.

1.2. Ohutusjuhised

- Seadet ei tohi paigutada soojusallika lähedusse!
- Seadet tohib ainult püstises asendis ladustada, transportida ja käituda!
- Kasutage seadmes ainult DAHLE nõuetele vastavaid vedelikke ja gaase!
- Seadet ei tohi avada!
- Seadet tohib kasutada vaid suletud ruumides, mille temperatuur jääb vahemikku 10 °C kuni 25 °C ja õhuniiskus vahemikku 15% kuni 19%.

- Veenduge, et hoone juhtmestik on lühisekindel (max 20 A).
- Seadet ei tohi tühjalt käitada!
- Kasutage sisestusshaite ühekaupa!



Viige kõrvaldamisele kuuluv dokumentipurustaja ettenähtud korras ja keskkonnanahoidlikult heakskiidetud kogumiskohta. Ärge visake paberipurustaja osi ega pakendit tavalisse olmeprügisse.

1.3. Piktogrammide legend



Oluline teave



Lugege kasutusteavet/ohutusmärkusi



TÄHELEPANU



Paigutage seade seinast 100 mm kaugusele põrandale seisma, tagage sooja õhu äravool. Rakendage seisupidurit (olenevalt mudelist)



Ärge kasutage seadet happeliste ainete läheduses.



Ärge kasutage seadet põlemisohtlike ainete või gaaside läheduses.



Automaatne käivitumine



Ärge jätke niiskesse keskkonda



Dokumentipurustaja ei sobi lastele kasutamiseks (toode pole mänguasi).



Ärge puudutage paberi sisestusava kätega!



Ärge puudutage paberi sisestusava riietega!



Ärge puudutage paberi sisestusava juustega!



Hoidke aerosoolpurgid eemal!



Enne purustamist eemaldage kirja- ja vihikuklambrid!



Ärge sisestage seadmesse diskette!



Enne hooldustöid lahutage paberipurustaja vooluvõrgust!



Tehnilised andmed –tootjal on õigus teha tehnilisi muudatusi!



Müratase seadme tühikäigu puhul



Paberi peenestamine



CD-/DVD-plaatide ribastamine



Kaartide ribastamine



Kaal



Seadme saab vooluvõrgust eraldada pistiku abil.



Pistikupesale peab olema tagatud vaba juurdepääs!



Käsitsemine



Paberipurustaja on kasutusvalmis

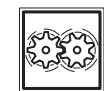

Paberipurustaja töötab



Automaatne väljalülitus!

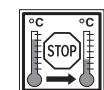

Pikemaajalise kasutamise ja/või ülekoormuse puhul lülitub dokumentipurustaja jahtumiseks automaatselt välja.



Hooldusjuhised / tõrgete kõrvaldamine



Mahuti on täis



Võimalikud tõrked



automaatne väljalülitamine avatud korpuse puhul

LT Originalios naudojimo instrukcijos vertimas



DĖMESIO!

Prieš pradėdami naudoti dokumentų smulkintuvą atidžiai perskaitykite naudojimo instrukciją ir saugos instrukcijas.

Būtina vadovautis instrukcijomis! Saugokite instrukcijas, kad paskaitytumėte ir vėliau.

Turinys

1.	Svarbi informacija	36
1.4.	Tiekiamas komplektas	60
1.5.	Techniniai duomenys	60
2.	Valdymas	61
2.5.	Popieriaus smulkinimas	62
2.8.	Perkrova („overload“)	63
2.10.	Perkaitimas („overheat“)	64
2.11.	CD/DVD, kortelių naikinimas	65
3.	Techninė priežiūra	66
3.1	Nuokarpų pašalinimas	66
3.3	Galimi gedimai	66
3.4	Įrenginio valymas	66

1.1. Naudojimas pagal paskirtį ir garantija

Šis dokumentų smulkintuvas skirtas popieriui smulkinti. Susidėvėjimo požymiams, gedimams dėl netinkamo naudojimo ir trečiųjų šalių remonto garantiniai įsipareigojimai ir apskritai garantija netaikoma.

Šis dokumentų smulkintuvas neskirtas pramoninio naudojimo reikmėms.

1.2. Saugos nuorodos

- Dokumentų smulkintuvo negalima statyti prie šilumos šaltinio!
- Įrenginį laikyti, gabenti ir naudoti leidžiama tik stačią!
- Su įrenginiu leidžiama naudoti tik tuos skysčius ir dujas, kurie atitinka DAHLE taikytinas direktyvas!
- Įrenginio negalima atidaryti!
- Siekiant apsaugoti nuo trumpojo jungimo reikia įrengti instaliacijos saugiklį (maks. 20 A stiprio).

- Dokumentų smulkintuvą leidžiama naudoti tik uždarose patalpose esant 10–25 °C temperatūrai ir 15–95 % oro drėgnumui be kondensacijos!
- Nenaudokite tuščio įrenginio!
- Įtraukimo angas naudoti tik po vieną!



Dokumentų smulkintuvą utilizuokite techniniu požiūriu tinkamu ir aplinkai nekenksmingu būdu, t. y. atiduokite jį įgaliojusiai atliekų tvarkymo įmonei. Dokumentų smulkintuvo dalių ir pakuotės neišmeskite su buitinėmis atliekomis.

1.3. Piktogramos



Svarbi informacija



Skaityti naudotojo informaciją/saugos instrukcijas



DĖMESIO



Įrenginį reikia stabiliai pastatyti ant grindų 100 mm atstumu nuo sienos, saugoti nuo įkaitimo pavojaus, įjungti stabdymo mechanizmą (priklauso nuo įrenginio tipo).



Draudžiama naudoti aparatą šalia edžių medžiagų.



Nenaudoti netoli degių skysčių arba dujų.



Automatinis įjungimas



Statykite tik ant sauso pagrindo



Šis dokumentų smulkintuvas neskirtas naudoti vaikams (gaminys nėra žaislas).



Nelieskite popieriaus tiektuvo rankomis.



Nekiškite prie popieriaus tiektuvo drabužių!



Nekiškite prie popieriaus tiektuvo plaukų!



Nelaikykite arti aerozolių!



Prieš naikindami dokumentus pašalinkite sąvaržėles ir sąsageles!



Negalima naikinti diskelių!



Prieš atlikdami priežiūros darbus dokumentų smulkintuvą atjunkite nuo maitinimo šaltinio!



Techniniai duomenys - Galimi techniniai pakeitimai!



Triukšmo lygis tuščiaja eiga

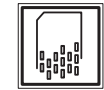

Popieriaus smulkinimas skiautėmis



CD/DVD smulkinimas juostelėmis



Kortelių smulkinimas juostelėmis



Masė



Tinklo kištukas skirtas elektros maitinimo šaltiniui atjungti!



Elektros maitinimo lizdas turi būti visada lengvai pasiekiamas!



Valdymas



Įrenginys parengtas veikti



Įrenginys naudojimo metu



Automatinis išjungimas!



Ilgo naudojimo ir (arba) perkrovos atveju dokumentų smulkintuvas išsijungia automatiškai, kad atvėstų.



Techninės priežiūros / gedimų šalinimo instrukcijos



Prisip. dėžė



Galimos triktys



Automatinis išjungimas, kai atidarytas dangtis

LV Tulkojums no sākotnējās lietošanas pamācības

UZMANĪBU!
Pirms sākat izmantot dokumentu smalcinātāju, lūdzam uzmanīgi izlasīt lietošanas pamācību un drošības norādes! Ievērojiet drošības norādes! Saglabājiet lietošanas pamācību turpmākai uzziņai.

Satura rādītājs

1.	Svarīga informācija.....	38
1.4.	Piegādes komplekts.....	60
1.5.	Tehniskie dati.....	60
2.	Apkalpošana.....	61
2.5.	Dokumentu smalcināšana.....	62
2.8.	Pārslogošana (overload).....	63
2.10.	Pārkaršana (overheat).....	64
2.11.	CD/DVD un karšu smalcināšana.....	65
3.	Apkope.....	66
3.1	Smalcinātāja iztukšošana.....	66
3.3	Iespējamie darbības traucējumi.....	66
3.4	Ierīces tīrīšana.....	66

1.1. Paredzētais pielietojums un garantija

Šis dokumentu smalcinātājs ir paredzēts papīra sasmalcināšanai.
Garantija neietver nodilumu, neprofesionālas lietošanas un trešās puses iejaukšanās rezultātā radītus ierīces bojājumus.
Šis smalcinātājs nav paredzēts rūpnieciskai izmantošanai.

1.2. Drošības norādes

- Ierīci nedrīkst uzstādīt karstuma avota tuvumā!
- Ierīce ir jāglabā, jāpārvadā un jāizmanto tikai vertikālā stāvoklī!
- Ierīcē drīkst izmantot tikai tādus šķidrumus un gāzes, kas atbilst DAHLE vadlīnijām!
- Ierīci nedrīkst atvērt!
- Nepieciešams nodrošināt ēkas elektroinstalāciju pret īsslēgumu (maks. 20 A).

- Ierīci drīkst izmantot tikai slēgtā telpā, kur gaisa temperatūra ir no 10 °C līdz 25 °C un kur gaisa mitrums no 15 % līdz 95 % neizraisa ūdens kondensāciju!
- Nepieļaujiet ierīces darbību tukšgaitā!
- Nedrīkst vienlaikus izmantot vairākas padeves atveres!

Dokumentu smalcinātāju utilizējiet pareizā veidā – nododiet to apstiprinātā savākšanas punktā. Neizmetiet dokumentu smalcinātāja daļas vai tā iepakojumu kopā ar sadzīves atkritumiem.

1.3. Paskaidrojumi par pictogrammām

- Svarīga informācija
- Izlasīt paziņojumu lietotājam/drošības norādes
- UZMANĪBU!
- Stabili uzstādīt ierīci uz grīdas 100 mm attālumā no sienas, nepieļaut siltuma uzkrāšanos ap ierīci, iedarbināt fiksēšanas mehānismu (atkarībā no ierīces veida)
- Ierīces tuvumā nedrīkst atrasties kodīgas vielas.
- Neizmantojot vidē, kur tuvumā ir viegli uzliesmojoši šķidrumi un gāzes.
- Automātiska darbības uzsākšana
- Sargāt no mitruma

- Dokumentu smalcinātāju aizliegts lietot bērniem (ši ierīce nav rotaļlieta)!
- Aizliegts ar rokām pieskarties papīra padeves vadotnei.
- Nedrīkst pieļaut apģērba nonākšanu papīra padeves vadotnē!
- Nedrīkst pieļaut matu nonākšanu papīra padeves vadotnē!
- Sargāt no aerosoliem!
- Pirms smalcināšanas izņemiet no dokumentiem skavas un noņemiet saspraudes!
- Aizliegts smalcināt datora disketes!
- Pirms smalcinātāja apkopes darbu sākuma atvienojiet ierīci no elektriskā tīkla!
- Tehniskie rādītāji - iespējamās tehniskas izmaiņas!
- Darbības troksnis tukšgaitā
- Papīra smalcināšana gabalos
- CD/DVD smalcināšana strēmēlēs
- Karšu smalcināšana strēmēlēs
- Svārs
- Tīkla kontaktspraudzis kalpo kā elektriskās strāvas padeves pārtraukšanas ierīce.
- Elektriskā tīkla kontaktligzdai vienmēr ir jābūt brīvi pieejamai!
- Apkalpošana
- Dokumentu smalcinātājs gatavs darbam
- Dokumentu smalcinātājs darbojas
- Automātiska izslēgšana!
- Ilgākas darbināšanas vai pārslodzes gadījumā dokumentu smalcinātājs automātiski izslēdzas, lai atdzistu.
- Apkopes norādījumi / darbības traucējumu novēršana
- Tvertne pilna
- Iespējamie traucējumi
- automātiski izslēdzas, kad atver korpusu

CZ Překlad originálního návodu k obsluze



UPOZORNĚNÍ!

Návod k obsluze a bezpečnostní pokyny ke skartovacímu zařízení si pozorně přečtěte PŘED jeho uvedením do provozu.

Dodržujte uvedené pokyny!

Návod k obsluze uchovejte pro případ pozdější potřeby.

Obsah

1.	Důležité informace	40
1.4.	Rozsah dodávky	60
1.5.	Technické údaje	60
2.	Obsluha	61
2.5.	Skartování papíru	62
2.8.	Přeplnění (overload)	63
2.10.	Přehřátí (overheat)	64
2.11.	Skartování CD/DVD a karet	65
3.	Údržba	66
3.1	Vysypávání skartovaného materiálu	66
3.3	Možné poruchy	66
3.4	Čistění zařízení	66

1.1. Účelové použití, ručení

Tento skartovač je určen ke skartování papíru.

Na opotřebení, poškození způsobené nevhodným použitím a na zásahy neautorizovaných opravčů se nevztahuje ručení ani záruka.

Toto skartovací zařízení není určeno pro průmyslové použití.

1.2. Bezpečnostní upozornění

- Zařízení neumísťujte do blízkosti zdrojů tepla!
- Zařízení skladujte, přepravujte a provozujte pouze v poloze ve stoje.
- Na zařízení používejte pouze kapaliny a plyny odpovídající směrnícím společnosti DAHLE.
- Zařízení nikdy neotvírejte!
- Zajistěte ochranu proti zkratu instalace systému (max. 20 A).

- Provozujte zařízení výhradně v uzavřených místnostech při teplotě 10 °C až 25 °C a nekondenzující vlhkosti vzduchu od 15 % do 95 %.
- Zařízení nenechávejte běžet naprázdno!
- Vstupní otvory používejte vždy odděleně!



Skartovací zařízení nechte ekologicky a odborně zlikvidovat autorizovanou sběrnou. Nevyhazujte žádné díly skartovače nebo balení do domácího odpadu.

1.3. Popis piktogramů



Důležitá informace



Přečtěte si informace pro uživatele/bezpečnostní pokyny



POZOR



Zařízení umístěte stabilně na podlahu s odstupem 100 mm ode zdi, tím zabráníte kumulaci tepla, zablokujte brzdy na kolečkách (podle typu zařízení)



Nepoužívejte zařízení v blízkosti žíravých látek.



Nepoužívejte zařízení v blízkosti hořlavých kapalin nebo plynů.



Automatický rozběh



Nepoužívejte ve vlhkém prostředí



Toto skartovací zařízení není určeno pro děti (tento produkt není hračka).



Otvoru pro vstup papíru se nedotýkejte rukama.



Zabraňte styku přívodu papíru s oblečením!



Pozor, aby se do vstupu pro papír nedostaly vlasy!



Uchovávejte spreje z dosahu přístroje!



Kancelářské sponky a sponky ze sešivaček před skartováním odstranit!



Nevkládejte žádné disky!



Před prováděním údržby skartovač odpojit od přívodu proudu!



Technické údaje — Technické změny vyhrazeny!



Provozní hluchost při chodu naprázdno



Řezání papíru na kusy



Řezání CD/DVD na proužky



Řezání karet na proužky



Hmotnost



Síťová zástrčka slouží jako dělicí zařízení od napájení ze sítě.



Síťová zástrčka musí být vždy snadno přístupná!



Obsluha



Skartovač v provozní pohotovosti



Skartovač v provozu



Automatické vypínání!



Při delším provozu a/nebo při přetížení se skartovací zařízení automaticky vypne, dokud nevychladne.



Pokyny pro údržbu/odstraňování závad



Zásobník plný



Možné poruchy



automatické vypnutí při otevření krytu

SK Preklad z pôvodného návodu na obsluhu



POZORI!

PRED uvedením skartovacieho prístroja do prevádzky si pozorne prečítajte návod na obsluhu a bezpečnostné pokyny.

Pokyny sa musia aplikovať!

Návod na obsluhu si uschovajte na neskoršie použitie.

Obsah

1.	Dôležité informácie	42
1.4.	Rozsah dodávky.....	60
1.5.	Technické údaje	60
2.	Obsluha.....	61
2.5.	Skartácia papiera	62
2.8.	Preplnený (overload).....	63
2.10.	Prehriaty (overheat).....	64
2:11.	Skartácia CD/DVD, kariet.....	65
3.	Údržba.....	66
3.1	Vyprázdenie skartovaného materiálu	66
3.3	Možné poruchy	66
3.4	Čistenie prístroja	66

1.1. Použitie zariadenia v súlade s určeným účelom, poskytnutie záruky

Tento skartovací prístroj je určený na skartáciu papiera. Ručenie ani záruka sa nevzťahuje na opotrebovanie, škody spôsobené neodborným používaním ani zásahy tretej strany. Tento skartovací prístroj nie je vhodný na priemyselné použitie.

1.2. Bezpečnostné pokyny

- Neinštalujte prístroj v blízkosti tepelného zdroja!
- Prístroj skladujte, prepravujte a prevádzkujte iba nastojato!
- Na prístroji používajte iba kvapaliny a plyny, ktoré zodpovedajú smerniciam spoločnosti DAHLE!
- Prístroj sa nesmie otvárať!
- Prístroj neprevádzkujte v chode naprázdno!

- Prístroj prevádzkujte iba v uzavretých priestoroch, pri 10 °C až 25 °C a nekondenzujúcej vlhkosti vzduchu od 15 % do 95 %!
- Zabezpečte skratovú odolnosť inštalácie budovy (max. 20 A).
- Zavádzače papiera používajte iba jednotlivito!



Skartovací prístroj zlikvidujte odborné a ekologicky na autorizovanom zbernom mieste. Žiadne časti skartovacieho prístroja alebo balenia nezhadzujte do domáceho odpadu.

1.3. Legenda piktogramov



Dôležitá informácia



Prečítajte si informáciu pre používateľa/bezpečnostné pokyny



POZOR



Prístroj stabilne nainštalujte na podlahu a vo vzdialenosti 100 mm od steny, zabráňte hromadeniu tepla, Stlačte ručné brzdy (v závislosti od typu)



Nepoužívať v blízkosti žieravých látok.



Nepoužívať v blízkosti horľavých kvapalín alebo plynov.



Automatický rozbeh



Nevystavujte vlhkosti



Tento skartovací prístroj nie je určený na používanie deťmi (výrobok nie je hračka).



Otvoru prívodu papiera sa nedotýkajte rukami!



Otvoru prívodu papiera sa nedotýkajte oděvom!



Otvoru prívodu papiera sa nedotýkajte vlasmi!



Do blízkosti neukladajte plechovky so sprejmi!



Pred skartovaním odstráňte z dokumentov kancelárske spinky a spony!



Nezasúvajte žiadne diskety!



Pred údržbárskymi prácami odpojte skartovací prístroj od napájacieho prúdu!



Technické údaje — Technické zmeny vyhradené!



Prevádzková hlasitosť pri chode naprázdno



Priečny rez papiera



Prúžkový rez CD/DVD



Prúžkový rez karty



Hmotnosť



Sieťová zástrčka slúži na oddelenie od napájania.



Sieťová zásuvka musí byť vždy ľahko prístupná!



Obsluha



Skartovací prístroj v pohotovostnom stave



Skartovací prístroj v prevádzke



Automatické vypnutie!



Pri dlhšej prevádzke a/alebo preťažení sa skartovací prístroj automaticky vypne, aby vychladol.



Pokyny na údržbu/odstraňovanie porúch



Nádoba je plná



Možné poruchy



automatické vypnutie pri otvorenom kryte

PL Tłumaczenie oryginalnej instrukcji obsługi

UWAGA!
PRZED uruchomieniem niszczarki należy uważnie przeczytać instrukcję obsługi oraz wskazówki bezpieczeństwa.
Należy przestrzegać wskazówek! Instrukcję obsługi należy zachować do późniejszego użytku.

Spis treści

1.	Ważne informacje.....	44
1.4.	Zakres dostawy	60
1.5.	Dane techniczne	60
2.	Obsługa.....	61
2.5.	Niszczanie dokumentów	62
2.8.	Przeładowanie (overload)	63
2.10.	Przegrzanie (overheat)	64
2.11.	Niszczanie CD/DVD i kart.....	65
3.	Konserwacja	66
3.1	Opróżnianie niszczarki	66
3.3	Możliwe przyczyny.....	66
3.4	Czyszczenie urządzenia	66

1.1. Użytkowanie zgodne z przeznaczeniem, gwarancja

Niniejsza niszczarka jest przeznaczona do niszczenia papieru.
Zużycie, szkody na skutek nieprawidłowego użycia oraz ingerencji osób trzecich nie są objęte ani rękojmią ani gwarancją.
Niniejsza niszczarka nie jest przeznaczona do zastosowań przemysłowych.

1.2. Wskazówki bezpieczeństwa

- Urządzenia nie ustawiać w pobliżu źródeł ciepła!
- Urządzenie składować, transportować i użytkować wyłącznie w pozycji pionowej!
- W urządzeniu stosować wyłącznie ciecze i gazy spełniające wytyczne DAHLE!
- Urządzenia nie wolno otwierać!
- Nie użytkować urządzenia na pusto!

- Urządzenie wolno użytkować wyłącznie w zamkniętych pomieszczeniach w temperaturze od 10 °C do 25 °C oraz przy niekondensującej wilgotności powietrza 15 % do 95 %!
- Należy zapewnić zabezpieczenie przeciwzwarciove w w instalacji budynku (maks. 20 A)!
- Z podajników korzystać tylko pojedynczo!

Niszczarkę usunąć w sposób nieszkodliwy dla środowiska przekazując do autoryzowanego punktu zbiórki. Żadnych elementów niszczarki lub jej opakowania nie wolno wyrzucać wraz z odpadami z gospodarstw domowych.

1.3. Objasnienie symboli

- Ważne informacje
- Przeczytać informacje dla użytkownika/wskazówki bezpieczeństwa
- UWAGA
- Niszczarkę ustawić na stabilnym podłożu w odległości 100 mm od ściany, unikać zatorów ciepłych, uruchomić hamulec postojowy (w zależności od typu)
- Urządzenia nie wolno użytkować w pobliżu substancji żrących
- Urządzenia nie wolno użytkować w pobliżu palnych cieczy lub gazów.
- Automatyczny rozruch

- Chronić urządzenie przed wilgocią
- Z niszczarki nie wolno korzystać dzieciom (produkt nie jest zabawką).
- Podajnika papieru nie wolno dotykać rękami!
- Podajnika papieru nie wolno dotykać częściami garderoby!
- Podajnika papieru nie wolno dotykać włosami
- Trzymać z dala puszek ze sprayem!
- Spinacze biurowe oraz zszywki usunąć przed przystąpieniem do niszczenia dokumentu!
- Nie wkładać dyskietek!
- Przed przystąpieniem do prac konserwacyjnych odłączyć niszczarkę od zasilania!
- Dane techniczne - Zmiany techniczne zastrzeżone!
- Głośność pracy na pusto
- Ścinki papieru
- Paski CD/DVD
- Paski kart
- Ciężar
- Wtyczka sieciowa służy do odłączania zasilania.
- Gniazdko sieciowe musi być w każdej chwili łatwo dostępne!
- Obsługa
- Niszczarka gotowa do pracy
- Niszczarka pracuje
- Automatyczne wyłączenie!
- Niszczarka wyłącza się automatycznie po dłuższym czasie pracy i/lub w razie przeciążenia w celu ostygnięcia.
- Wskazówki konserwacyjne / Usuwanie usterek
- Pełny pojemnik
- Możliwe zakłócenia
- Automatyczne wyłączenie w przypadku otwarcia obudowy

RO Traducere din instrucțiunile de utilizare originale

ATENȚIE!
Înainte de punerea în funcțiune a distrugătorului de documente, citiți cu atenție instrucțiunile de utilizare și indicațiile privind siguranța!
Normele de siguranță trebuie aplicate!
Păstrați instrucțiunile pentru a le putea consulta ulterior.

Cuprins

1.	Informații importante	46
1.4.	Pachetul de livrare	60
1.5.	Date tehnice	60
2.	Utilizare	61
2.5.	Distrugerea hârtiei	62
2.8.	Supraîncărcare (overload)	63
2.10.	Supraîncălzire (overheat)	64
2.11.	Distrugerea de CD-uri/DVD-uri, carduri	65
3.	Întreținere	66
3.1	Evacuarea materialului tocat	66
3.3	Avarii posibile	66
3.4	Curățarea echipamentului	66

1.1. Utilizarea conform destinației prevăzute, garanția standard

Distrugătorul de documente este conceput pentru distrugerea hârtiei.
Uzura și deteriorările cauzate de utilizarea neadecvată și de intervențiile terților asupra dispozitivului nu fac obiectul garanției standard sau al garanției extinse.
Distrugătorul de documente nu este adecvat pentru utilizare industrială.







1.2. Indicații privind siguranța













- Nu amplasați dispozitivul în apropierea unei surse de căldură!
- Depozitați, transportați și utilizați dispozitivul numai în poziție verticală!
- Utilizați pentru distrugătorul de documente numai lichide și gaze conforme cu reglementările DAHLE!

- Dispozitivul nu trebuie deschis!
- Este permisă utilizarea dispozitivului numai în spații închise, la temperaturi cuprinse între 10°C și 25°C și la o umiditate atmosferică fără condensare cuprinsă între 15% și 95%!
- Trebuie asigurată protecția la scurtcircuit a instalației clădirii (max. 20A).
- Nu lăsați distrugătorul de documente să funcționeze în gol!
- Fantele de alimentare trebuie folosite una câte una!

 **Eliminați distrugătorul de documente în mod corect și ecologic, la un centru autorizat de colectare a deșeurilor. Nu aruncați componente ale distrugătorului de documente sau ale ambalajului la gunoii menajer.**

1.3. Legenda pictogramelor

-  Informație importantă
-  Consultați informațiile pentru utilizatori/instrucțiunile privind siguranța
-  Atenție
-  Amplasați dispozitivul în poziție stabilă la nivelul solului și la o distanță de 100 mm față de perete, evitați acumularea de căldură, Acționarea frânelor de blocare (în funcție de tip)
-  A nu se utiliza în apropierea substanțelor corozive.
-  A nu se utiliza în apropierea lichidelor și a gazelor inflamabile.
-  Pornire automată

-  A nu se expune la umezeală
-  Distrugătorul de documente nu este conceput pentru a fi utilizat de copii (produsul nu este un obiect de joacă).
-  Nu atingeți fanta pentru intrarea hârtiei cu mâinile.
-  Nu atingeți fanta pentru intrarea hârtiei cu obiecte de îmbrăcăminte!
-  Nu atingeți fanta pentru intrarea hârtiei cu părul!
-  Țineți la distanță tuburile de spray!
-  Îndepărtați capselle și clemele de hârtie înainte de distrugerea documentelor!
-  Nu introduceți dischete!
-  Înainte de executarea lucrărilor de întreținere, deconectați dispozitivul de la alimentarea cu curent!
-  Date tehnice - Rezervat dreptul de a efectua modificări tehnice!
-  Nivelul de zgomot la funcționarea în gol
-  Tăierea în particule a hârtiei
-  Tăierea în fâșii a CD-urilor/DVD-urilor

-  Tăierea în fâșii a cardurilor
-  Greutate
-  Ștecherul servește ca dispozitiv de deconectare de la alimentarea cu curent electric!
-  Priza de alimentare cu curent electric trebuie să fie facil accesibilă în orice moment!
-  Utilizare
-  Distrugătorul de documente pregătit de funcționare
-  Distrugătorul de documente în funcțiune
-  Oprire automată!
-  În cazul unei funcționări mai îndelungate și/sau în caz de suprasarcină, distrugătorul de documente se oprește automat în scop de răcire.
-  Instrucțiuni pentru lucrări de întreținere / remediarea defecțiunilor
-  Recipient plin
-  Avarii posibile
-  Aparatul se oprește automat atunci când este deschis

BG Превод от оригиналното ръководство за употреба



ВНИМАНИЕ!

ПРЕДИ пускане в експлоатация на машината за унищожаване на документи, прочетете ръководството за употреба и препоръките за безопасност. Указанията трябва да се прилагат! Съхранявайте ръководството за бъдеща употреба.

Съдържание

1.	Важни информации.....	48
1.4.	Окомплектовка на доставката	60
1.5.	Технически данни.....	60
2.	Употреба	61
2.5.	Унищожаване на хартия	62
2.8.	Претоварване (overload).....	63
2.10.	Прегряване (overheat)	64
2.11.	Унищожаване на CD/DVD, карти	65
3.	Поддръжка.....	66
3.1	Изпразване на нарязания материал.....	66
3.3	Възможни неизправности	66
3.4	Почистване на уреда.....	66

1.1. Използване по предназначение, гаранция

Тази машина за унищожаване на документи е предназначена за унищожаване на хартия.

Износване, повреди поради некомпетентна употреба, както и намеси на трети лица, не попадат под гаранцията.

Тази машина за унищожаване на документи не е подходяща за промишлена употреба.

1.2. Указания за безопасност

- Указания за безопасност
- Уредът да не се поставя в близост до източник на топлина!
- Уредът да се складира, транспортира и експлоатира само в изправено положение!
- В уреда да се използват само течности и газове, които съответстват на директивите на DAHLE!

- Не се допуска отварянето на уреда!
- Уредът да се експлоатира само в затворени помещения, при 10°C до 25°C и некондензираща въздушна влажност от 15% до 95%!
- Да се гарантира безопасността на инсталацията на сградата при късо съединение (макс. 20A).
- Уредът да не се експлоатира на празен ход!
- Чекмеджетата да се използват само поотделно!

 **Изхвърляйте машината за унищожаване на документи компетентно и екологично в оторизиран събирателен пункт. Не изхвърляйте части от машината за унищожаване на документи или от опаковката с битовата смет.**

1.3. Легенда на пиктограмите



Важни информации



Да се прочете информацията за потребителя/препоръките за безопасност



ВНИМАНИЕ



Уредът да се постави стабилно на пода и на разстояние от 100 mm от стената, да се избягва акумулиране на топлина, Задействане на застопоряващите спиралки (в зависимост от типа)



Да не се използва в близост до разяждащи вещества.



Да не се използва в близост до горими течности или газове.



Автоматично пускане



Да не се излага на влага



Тази машина за унищожаване на документи не е предназначена за използване от деца (продуктът не е играчка).



Не докосвайте с ръце подаването на хартията.



Не докосвайте с части от облеклото подаването на хартията!



Не докосвайте с косите подаването на хартията!



Дръжте далеч флакони със спрей!



Кламерите да се отстраняват преди процеса на унищожаване!



Не вкарвайте дискети!



Преди работи по поддръжката, машината за унищожаване на документи да се изключи от електрозахранването!



Технически данни - запазено правото за технически промени!



Работен шум на празен ход



Рязане на хартията на частици



Рязане на CD/DVD на ивици



Рязане на карти на ивици



Тегло



Мрежовият щепсел служи за разделящо устройство на електрозахранването.



Мрежовият контакт трябва по всяко време да е лесно достъпен!



Употреба



Машината за унищожаване на документи в готовност



Машината за унищожаване на документи при работа



Автоматично изключване!



При по-дълга експлоатация и/или претоварване, машината за унищожаване на документи се изключва автоматично за охлаждане.



Указания за поддръжка / отстраняване на неизправности



Контейнер пълнен



Възможни неизправности



автоматично изключване при отворен корпус

TR Orijinal kullanım kılavuzundan çeviri



DİKKAT!

Dosya yok edicisini çalıştırmadan ÖNCE kullanım kılavuzunu ve güvenlik uyarılarını dikkatle okuyun.



Uyarılar uygulanmalıdır!

Kullanım kılavuzunu bir başvuru kaynağı olarak dikkatle muhafaza edin.

İçindekiler

1.	Önemli bilgiler	50
1.4.	Teslimat kapsamı	60
1.5.	Teknik bilgiler	60
2.	Kullanım	61
2.5.	Kağıt imhası	62
2.8.	Aşırı yüklenme (overload)	63
2.10.	Aşırı ısınma (overheat)	64
2.11.	CD/DVD, kart imhası	65
3.	Bakım	66
3.1	Kesilen atıkları boşaltma	66
3.3	Olası arızalar	66
3.4	Cihazı temizleme	66

1.1. Amacına uygun kullanım, garanti

Dosya yok edicisi kağıtların imha edilmesi için tasarlanmıştır.

Aşınma, amacının dışında kullanım sonucu oluşan hasarlar ve üçüncü şahısların müdahaleleri garanti kapsamına girmezler.

Dosya yok edicisi endüstriyel kullanım için uygun değildir.

1.2. Güvenlik uyarıları

- Cihazı, ısı kaynağının yakınına monte etmeyin!
- Cihazı sadece dik şekilde depolayın, taşıyın ve çalıştırın!
- Cihazda yalnızca DAHLE yönergelerine uygun sıvılar ve gazlar kullanın!
- Cihaz açılmamalıdır!
- Cihazı sadece kapalı mekanlarda, 10 °C ile 25 °C arasındaki sıcaklıklarda %15 ile %95 arasındaki yoğunlaşmayan hava nemliliğinde çalıştırın!

- Bina tesisatının kısa devre emniyeti sağlanmalıdır (maks. 20 A).
- Cihazı boşta çalıştırmayın!
- İçeri çekme yuvaları sadece tek tek kullanılmalıdır!



Dosya yok edicisini teknolojiye ve çevreye uygun bir şekilde yetkili bir toplama yerinde imha edin. Dosya yok edicisinin parçalarını veya ambalajını ev çöpüne atmayın.

1.3. Piktogram açıklaması



Önemli bilgi



Kullanıcı bilgisi/güvenlik uyarılarını okuyun



DİKKAT



Cihazı güvenli duracak şekilde ve duvara 100 mm mesafede kurun, ısı birikmesini önleyin, Sabitleme frenlerini devreye alın (tipe bağlı)



Aşındırıcı maddelerin yakınında kullanmayın.



Yanıcı sıvıların ve gazların yakınında kullanmayın.



Otomatik çalışma



Islaklığa maruz bırakmayın



Bu dosya yok edicisi çocuklar tarafından kullanılmak üzere tasarlanmamıştır (ürün, oyuncak değildir).



Kağıt beslemesine ellerinizle dokunmayın.



Kağıt beslemesine elbiseleriniz değmemelidir!



Kağıt beslemesine saçlarınızla dokunmayın!



Sprey kutularını uzak tutun!



Yok etmeden önce kısıkaçları ve ataçları çıkarın!



Disket yerleştirmeyin!



Bakım çalışmalarından önce dosya yok edicisini elektrik beslemesinden ayırın!



Teknik veriler - Teknik değişiklik yapma hakkı saklıdır!



Boşta çalışırken çalışma sesi

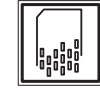

Kağıt partikül kesim



CD/DVD şerit kesim



Kart şerit kesim



Ağırılık



Fiş, elektrik kaynağından ayırma tertibatı olarak kullanılır.



Elektrik prizi her an için erişilbilir olmalıdır!



Kullanım



Dosya yok edicisi hazır



Dosya yok edicisi çalışıyor



Otomatik kapatma!

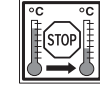

Uzun süreli işletimde ve/veya aşırı yüklenme durumunda dosya yok edicisi otomatik olarak soğumak için kapanır.



Bakım bilgileri/arıza giderme



Hazne dolu



Olası arızalar



Gövde açık iken otomatik kapanma

GR Μετάφραση του πρωτότυπου εγχειριδίου χρήσης

ΠΡΟΣΟΧΗ!
 ΠΡΙΝ από την έναρξη λειτουργίας του καταστροφέα εγγράφων διαβάστε προσεκτικά το εγχειρίδιο χρήσης και τις υποδείξεις ασφαλείας.
 Πρέπει να τηρούνται οι υποδείξεις! Το εγχειρίδιο χρήσης πρέπει να φυλάσσεται για μεταγενέστερη χρήση.

Πίνακας περιεχομένων

1.	Σημαντικές πληροφορίες	52
1.4.	Παραδοτέα	60
1.5.	Τεχνικά στοιχεία	60
2.	Χειρισμός	61
2.5.	Καταστροφή χαρτιού	62
2.8.	Υπερφόρτωση (overload)	63
2.10.	Υπερθέρμανση (overheat)	64
2.11.	Καταστροφή CD/DVD, καρτών	65
3.	Συντήρηση	66
3.1	Εκκένωση προϊόντων κοπής	66
3.3	Πιθανές βλάβες	66
3.4	Καθαρισμός συσκευής	66

1.1. Ενδεδειγμένη χρήση, παροχές εγγύησης

Αυτός ο καταστροφέας εγγράφων προορίζεται για την καταστροφή χαρτιού. Η φθορά, οι ζημιές από ακατάλληλη χρήση καθώς και οι επεμβάσεις από τρίτους δεν περιλαμβάνονται στις παροχές της εγγύησης ούτε καλύπτονται από εγγύηση. Αυτός ο καταστροφέας εγγράφων δεν ενδείκνυται για βιομηχανική χρήση.



1.2. Υποδείξεις ασφαλείας





- Υποδείξεις ασφαλείας
- Η συσκευή δεν επιτρέπεται να τοποθετείται κοντά σε πηγές θερμότητας!
- Αποθηκεύετε, μεταφέρετε και λειτουργείτε τη συσκευή μόνο σε όρθια θέση!
- Χρησιμοποιείτε στη συσκευή μόνο υγρά και αέρια που πληρούν τις οδηγίες DAHLE!

- Η συσκευή δεν επιτρέπεται να ανοίγεται!
- Η λειτουργία της συσκευής επιτρέπεται μόνο σε κλειστούς χώρους, με θερμοκρασία από 10°C έως 25°C και μη συμπυκνωμένη υγρασία αέρα από 15% έως 95%!
- Πρέπει να διασφαλίζεται η προστασία από βραχυκύκλωμα στην κτιριακή εγκατάσταση (έως 20A).
- Η συσκευή δεν πρέπει να λειτουργεί άδεια!
- Οι θήκες τροφοδοσίας πρέπει να χρησιμοποιούνται μόνο ξεχωριστά!

 **Ο καταστροφέας εγγράφων πρέπει να απορρίπτεται σωστά και με περιβαλλοντικά ορθό τρόπο σε εξουσιοδοτημένο κέντρο συλλογής. Μην ρίχνετε μέρη του καταστροφέα εγγράφων ή της συσκευασίας στα οικιακά απορρίμματα.**

1.3. Λεζάντες εικονογραμμάτων

-  Σημαντική πληροφορία
-  Διαβάστε τις πληροφορίες χρήστη και τις υποδείξεις ασφαλείας

-  **ΠΡΟΣΟΧΗ**
 Η συσκευή πρέπει να τοποθετείται με στατική ασφάλεια στο δάπεδο, σε απόσταση 100 mm από τον τοίχο και να αποφεύγεται η συσσώρευση θερμότητας. Να χρησιμοποιούνται τα φρένα ακινητοποίησης (ανάλογα με τον τύπο)
-  Δεν επιτρέπεται η χρήση κοντά σε διαβρωτικά υλικά.
-  Δεν επιτρέπεται η χρήση κοντά σε εύφλεκτα υγρά ή αέρια.
-  Αυτόματη εκκίνηση λειτουργίας

-  Δεν επιτρέπεται η έκθεση σε υγρασία
-  Αυτός ο καταστροφέας εγγράφων δεν προορίζεται για χρήση από παιδιά (το προϊόν δεν είναι παιχνίδι).
-  Μην αγγίζετε με τα χέρια την τροφοδοσία χαρτιού.
-  Μην αγγίζετε με μέρη της ενδυμασίας την τροφοδοσία χαρτιού!
-  Τα μαλλιά σας δεν πρέπει να αγγίζουν την τροφοδοσία χαρτιού!
-  Κρατάτε μακριά τυχόν δοχεία ψεκασμού!
-  Οι συνδετήρες γραφείου και συρραπτικών πρέπει να αφαιρούνται πριν από τη διαδικασία καταστροφής!
-  Μην εισάγετε δισκέτες!
-  Πριν από εργασίες συντήρησης αποσυνδέετε τον καταστροφέα εγγράφων από την τροφοδοσία ρεύματος!
-  Τεχνικά στοιχεία - Με την επιφύλαξη του δικαιώματος τεχνικών αλλαγών!
-  Ένταση ήχου σε άδεια λειτουργία
-  Κοπή χαρτιού σε τεμάχια
-  Κοπή CD/DVD σε λωρίδες
-  Κοπή καρτών σε λωρίδες
-  Βάρος
-  Το φις δικτύου ρεύματος χρησιμεύει ως διάταξη αποσύνδεσης της τροφοδοσίας ρεύματος.
-  Η πρίζα πρέπει να είναι εύκολα προσβάσιμη ανά πάσα στιγμή!
-  Χειρισμός
-  Καταστροφέας εγγράφων σε λειτουργική ετοιμότητα
-  Καταστροφέας εγγράφων σε λειτουργία
-  Αυτόματη απενεργοποίηση!
-  Κατά την παρατεταμένη λειτουργία και/ή υπερφόρτωση ο καταστροφέας εγγράφων μεταβαίνει αυτόματα σε λειτουργία ψύξης.
-  Υποδείξεις συντήρησης / Αντιμετώπιση βλαβών
-  Κάδος γεμάτος
-  Πιθανές διαταραχές
-  Αυτόματη απενεργοποίηση με ανοιχτό περίβλημα



لا تُعرّض للبلل



ماكينة تقطيع الورق هذه غير مخصصة لاستخدام الأطفال (لا يعتبر المنتج لعبة).



لا تلمس مغذي الورق بيديك.



لا تلمس مغذي الورق بقطع من الملابس.



لا تلمس مغذي الورق بيديك.



أبعدها عن لعب الرذاذ!



يجب إزالة مشابك ودبابيس الورق قبل إجراء عملية تقطيع الورق!



لا تقم بإدخال الأقراص!



قبل القيام بأعمال الصيانة يجب فصل ماكينة تقطيع الورق عن إمداد الطاقة!



البيانات التقنية - يُحتفظ بالحق في عمل تغييرات تقنية!



مستوى صوت التشغيل على سرعة التباطؤ



تقطيع الورق على شكل جزئيات صغيرة



تقطيع الأقراص المضغوطة/أقراص DVD على شكل أشربة



تقطيع البطاقات على شكل أشربة



الوزن



يُستخدم قابس التيار كتجهيزة قطع لإمداد الطاقة.



يجب أن يكون مقبس الطاقة في موضع يسهل الوصول إليه في أي وقت!



الاستعمال



ماكينة تقطيع الورق في وضع الاستعداد



ماكينة تقطيع الورق قيد التشغيل



الفصل الأوتوماتيكي!



عند التشغيل لفترات طويلة و/أو التحميل الزائد تفصل ماكينة قطع الأوراق أوتوماتيكيًا للتبريد.



تعليمات الصيانة / إصلاح الأعطال



الوعاء ممتلئ



حالات الخلل المحتملة



الفصل الأوتوماتيكي عند التشغيل عند فتح العلبة

ترجمة من دليل الاستعمال الأصلي

- لا تقم بتشغيل الماكينة إلا في أماكن مغلقة. وفي رطوبة غير درجة حرارة من 10 مئوية إلى 25 مئوية ونسبة متكاثفة من 15% إلى 95%.

- يجب الحماية من قصر الدائرة بتركيبات البناء (الحد الأقصى 20 أمبير).

- لا يتم تشغيل الماكينة على سرعة التباطؤ!

- تستعمل الملقمات كل على حدة!

تخلص من ماكينة تقطيع الورق بطريقة سليمة وصديقة للبيئة بإحدى نقاط التجميع المعتمدة.

لا تضع أي جزء من أجزاء ماكينة تقطيع الورق أو تغليفها في القمامة المنزلية.



معلومات هامة



اقرأ معلومات المستخدم/تعليمات الأمان



تنبيه

توضع ماكينة تقطيع الورق في وضع مستقر على الأرضية وعلى مسافة 100 ملم من الحائط. تجنب الحرارة المنخفضة. يُضغَط على فرامل التثبيت (متعلق بالنوع)



لا تُستخدم بالقرب من مواد كاوية.



لا تُستخدم بالقرب من سوائل أو غازات سريعة الاشتعال.



يتم التشغيل أوتوماتيكيًا



تنبيه!

قم بقراءة دليل الاستعمال وتعليمات

الأمان بعناية قبل بدء تشغيل ماكينة

تقطيع الورق.

لا بد من تطبيق هذه التعليمات.

احتفظ بدليل الاستعمال لاستخدامه لاحقًا.

المحتويات

1. معلومات هامة 54

1.4. محتويات العبوة 60

1.5. البيانات التقنية 60

2. الاستعمال 61

2.5. تقطيع الورق 62

2.8. الحمل الزائد 63

2.10. الحرارة الزائدة 64

2.11. تقطيع الأقراص المضغوطة/أقراص DVD والبطاقات 65

3. الصيانة 66

3.1. تفرغ الفصصات 66

3.3. حالات الخلل المحتملة 66

3.4. تنظيف الماكينة 66

1.1. الاستخدام المقصود والضمان

ماكينة تقطيع الورق هذه مخصصة لتدمير الورق. أي تآكل وتلف ناتج عن الاستخدام غير الملائم وعبث طرف ثالث لا يدخل ضمن الضمان.

لا تصلح ماكينة تقطيع الأوراق هذه للاستخدام الصناعي

1.2. تعليمات الأمان

- لا تضع الماكينة بالقرب من مصدر حرارة!

- لا تُخزّن الماكينة ولا تُنقل ولا تُشغل إلا وهي قائمة في وضع رأسي!

- لا تُستخدم في الماكينة إلا السوائل والغازات التي تتفق مع توجيهات شركة DAHLE!

- لا تقم بفتح الماكينة!

JP 取扱説明書原本からの翻訳

注意!
ご使用前に、本製品の取扱説明書に記載されている使い方や安全上の注意をよくお読みください。
安全上の指示を必ず守ってご使用ください。
取扱説明書はいつでも読めるように保管しておいてください

目次

1. 重要事項	56
1.4. 製品の内容	60
1.5. 技術仕様	60
2. 操作方法	61
2.5. 用紙の裁断	62
2.8. 過負荷 (オーバーロード)	63
2.10. 過熱 (オーバーヒート)	64
2.11. CD/DVD、カードの裁断	65
3. メンテナンス	66
3.1. ダストボックスを空にする	66
3.3. 故障かなと思ったら	66
3.4. お手入れ方法	66

1.1. 正しい使用法、製品の保証について

このシュレッダーは紙を裁断するためにつくられています。
指示に従わなかったり、用途以外のものを投入したことで生じた故障や損害について、当社は一切の責任を負いません。また、これらの故障や損害は当社保証の対象外となります。
本製品は産業用シュレッダーには適していません。



1.2. 安全に関するご注意





- 本機を熱源のそばに置かないでください。
- 本機は決して倒さず、縦にして保管や移動をしてください。
- ダーレ社の純正シュレッダーオイル、ガス以外は使用しないでください。
- 本体を決して開けないでください。



























- 本機は温度 10°C~25°Cの閉めきった部屋で使用してください。また、湿度は15%~95%以内を保ち、結露しないように注意してください。
- 建物の配線設備の短絡保護装置が正常に作動することを ご確認ください(最大20 A)。
- 本機を空回らせないでください。
- エアシャフトは必ず単体で使用してください。

 シュレッダーを廃棄する際は分別方法および環境に配慮し、自治体の指示に従ってください。シュレッダーのパーツや梱包材は、一般ごみとして廃棄しないでください

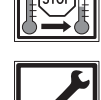

1.3. ピクトグラムの説明

-  重要事項
-  取扱説明書/安全に関する注意事項をお読みください

-  注意
本機は床にしっかり安定させ、壁面から100 mm 離して設置してください。また、本体内部が過熱しないよう注意し、必ずストッパーを使用してください (機種により異なる)
-  本製品を錆びつく恐れのある物質の近くで使用しないでください。
-  可燃性の液体やガスの近くでは使わないでください。
-  オートスタート

-  湿度の高い場所に放置しないでください。
-  本製品は、お子様向けのものではありません。(シュレッダーで遊ばないこと)。
-  用紙投入口に手を触れないでください。
-  用紙投入口に服が巻き込まれないようご注意ください。
-  用紙投入口に髪の毛が巻き込まれないようご注意ください。
-  スプレー缶を近づけないでください。
-  用紙クリップやホチキスはシュレッダーにかける前に外してください。
-  フロッピーディスクは本機で裁断できません。
-  メンテナンスを行う前に、必ず電源プラグを抜いてください。
-  技術仕様 - 内容は予告なく変更される場合があります
-  空回り時の騒音レベル
-  用紙 - クロスカット
-  CD/DVD - ストレートカット
-  カード - ストレートカット
-  質量
-  プラグで電源の入/切を行います
-  電源プラグはいつでもすぐに抜き差しできるようにしておいてください。
-  操作
-  スタンバイ中
-  作動中
-  オートオフ
-  長時間作動したり過負荷の状態になると、自動的にオフになって本体を冷まします。
-  メンテナンスについて / トラブルの解消
-  ダストボックスが満杯です
-  故障かなと思ったら
-  本機が開いたままになった場合のオートオフ機能

CN 原始操作说明书的翻译

 **注意!**
使用碎纸机之前, 请仔细阅读本操作说明书和安全指南。
 必须遵守本指南的内容!
妥善保管本操作说明书, 以备将来使用。

目录

1. 重要信息	58
1.4. 供货范围	60
1.5. 技术数据	60
2. 操作	61
2.5. 纸张粉碎	62
2.8. 过载 (overload)	63
2.10. 过热 (overheat)	64
2.11. CD/DVD、卡片粉碎	65
3. 维护	66
3.1 清空粉碎物	66
3.3 可能的故障	66
3.4 清洁设备	66

1.1. 预定用途, 保修

本碎纸机用于粉碎纸张。
由于不恰当使用或从第三方购买造成的磨损及损坏不属于保修或保证范围。
本碎纸机不适合工业用途。

1.2. 安全指南

- 不要将本设备置于热源附近!
- 本设备只能以直立状态放置、运输及运行!
- 本设备上只能使用符合 DAHLE 规定的液体或气体!
- 不要打开本设备!
- 本设备只能在温度为 10° C 至 25° C 且非凝湿度为 15% 至 95% 的室内使用!
- 确保房屋安装的短路保险丝工作正常

(最大电流 20 安) !
- 不要让设备空转!
- 只能单独使用进料槽!

 以专业环保方式报废碎纸机, 将垃圾送到认可的回收站处置。请不要将碎纸机的部件或包装与生活垃圾一同处置。

1.3. 图形符号

-  重要信息
-  阅读使用者信息/安全指南
-  注意
-  将本设备平稳地直立在地面上, 离墙 100 毫米, 避免操作紧急制动时, 热量积聚 (取决于型号)
-  使用时请远离腐蚀性物品。
-  使用时请远离易燃易爆液体及气体。
-  自动开机
-  不要暴露在潮湿的环境中

-  不要让儿童使用本碎纸机 (本产品不是玩具)。
-  请不要用手接触进纸入口。
-  请不要让衣服接触进纸入口!
-  请不要让毛发接触进纸入口!
-  远离喷雾罐!
-  请在销毁文件前去掉回形针和订书针!
-  未插入软盘!
-  维修碎纸机前要断电!
-  技术数据 — 保留技术变更的权利!
-  空转时的机器噪音
-  纸张碎粒
-  CD/DVD 碎片
-  卡片碎片
-  重量
-  电源插头用作断电装置!
-  电源插座应随时方便使用!
-  操作
-  准备状态下的碎纸机
-  使用状态下的碎纸机
-  自动关机!
-  在延长操作时间和/或过载时, 碎纸机会自动关机以降温。
-  维护指南 / 故障排除
-  容器已满
-  可能的故障
-  打开机壳时会自动关机

1.



1.4.

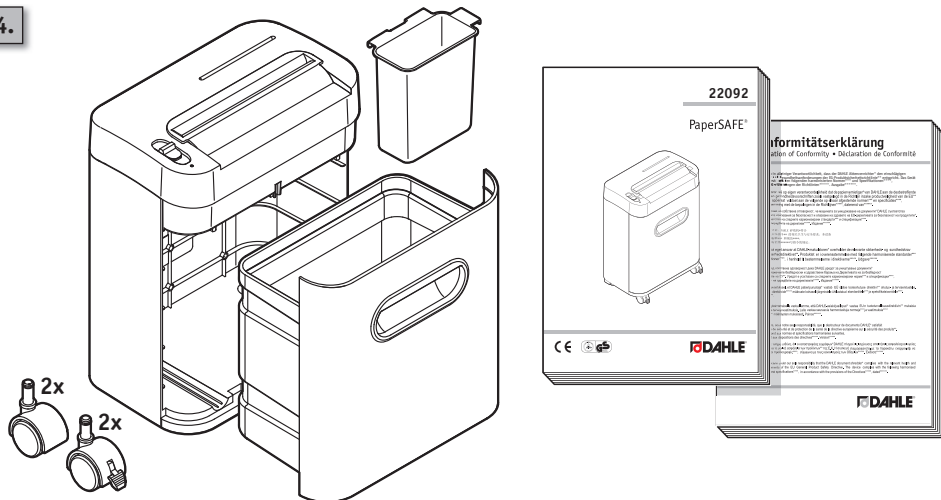

1.5.

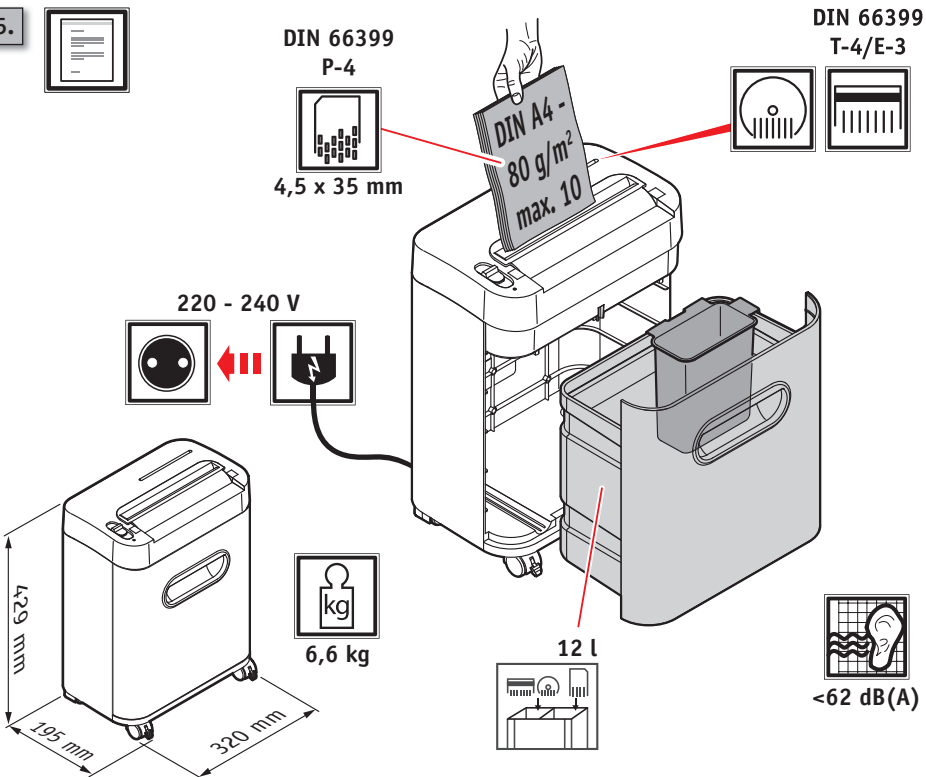

2.



2.1.



2.2.

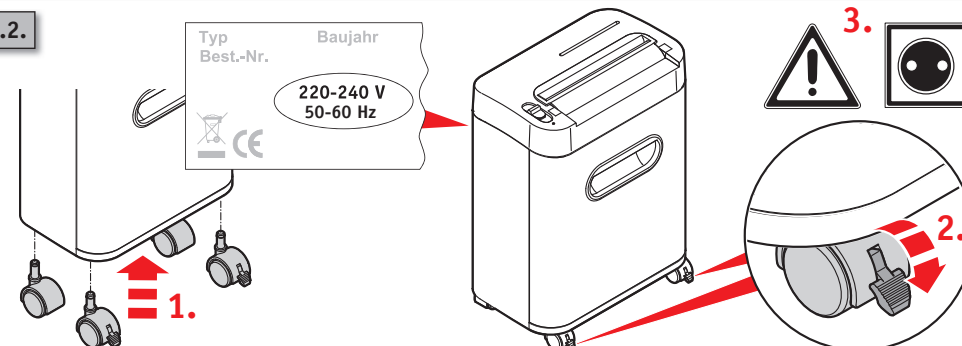

2.3.

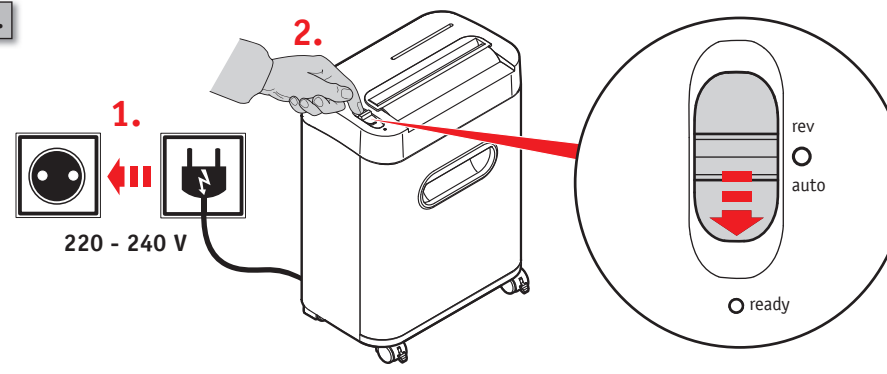

2.4.

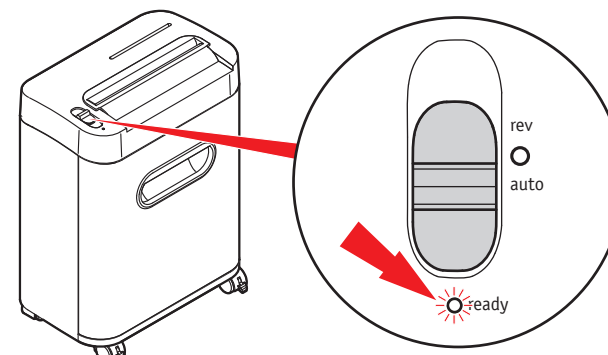

2.



2.5.



2.6.

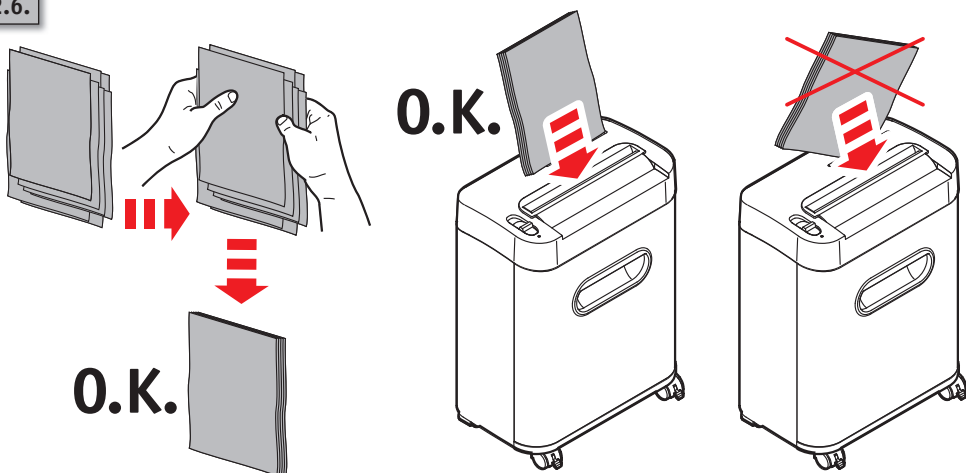

2.7.

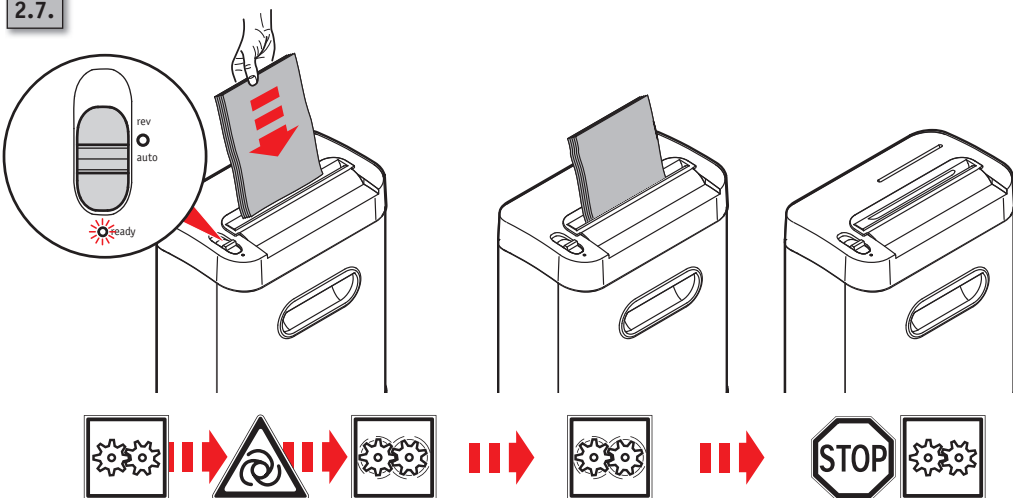

2.



2.8.

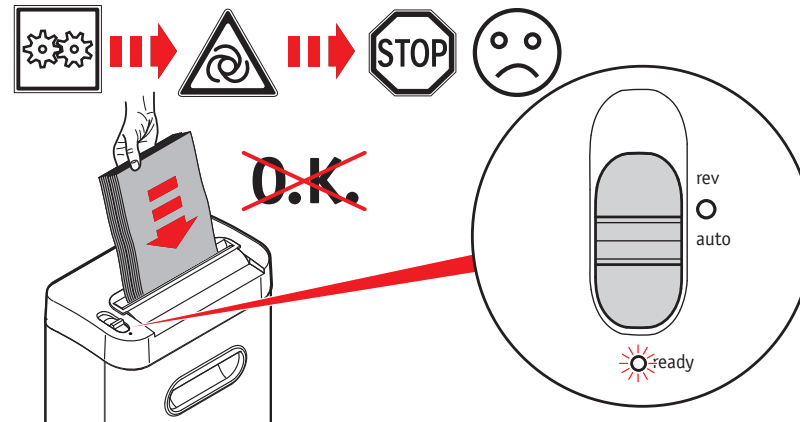

2.9.

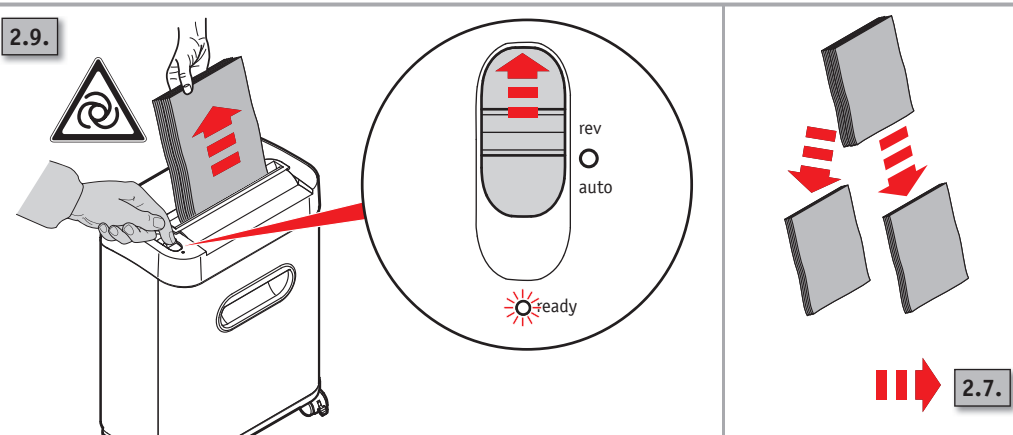

2.10.

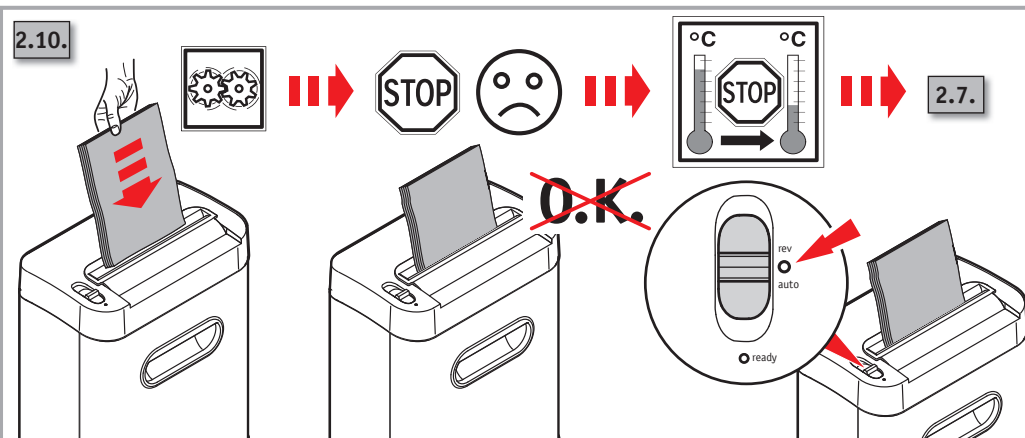

2.



2.11.



2.12.

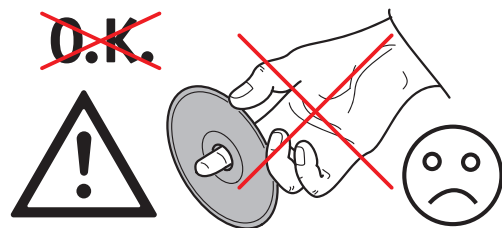
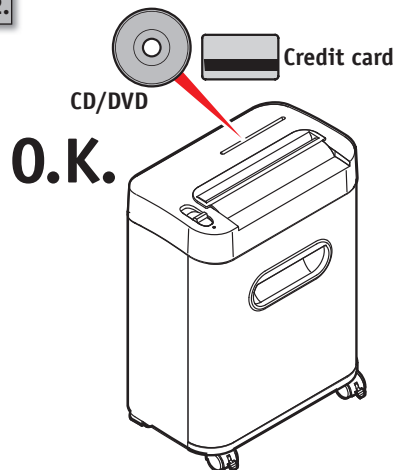

2.13.

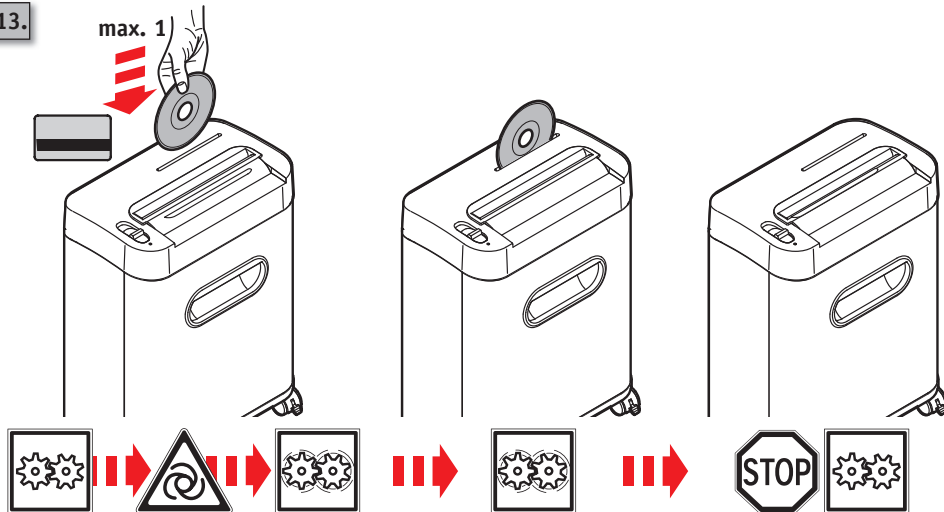

3.



3.1.

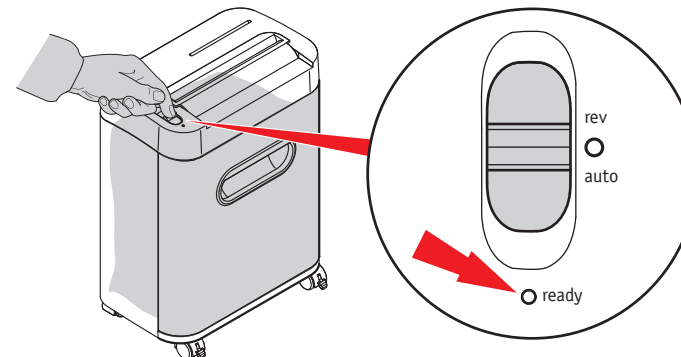

3.2.



1.

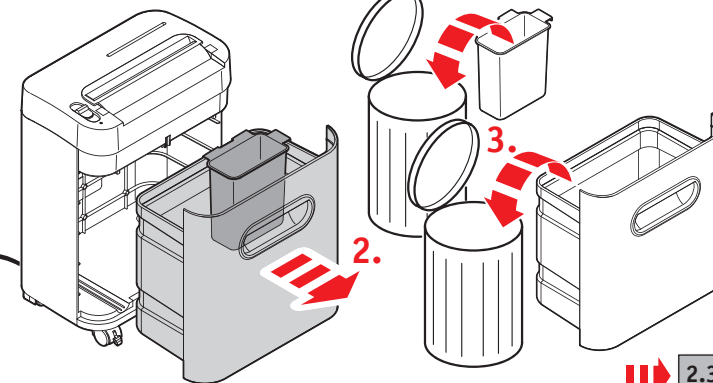

2.3.

3.3.



ready



ready

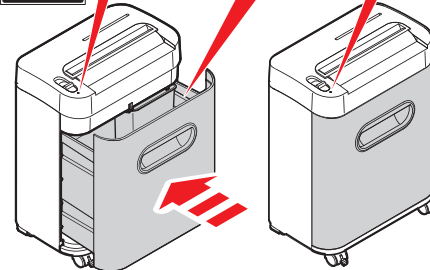

3.4.



1.

